



CRISTINA

# OXYZKIN

OXYGEN THERAPY



คุณรู้หรือไม่ว่าการอาบน้ำแบบเดิมๆ ไม่สามารถชำระล้างสิ่งสกปรกได้ 100% และเป็นสาเหตุที่ทำให้ผิวหนังของเราเสื่อมสภาพเร็วขึ้น เพราะในแต่ละวันที่เราเผชิญกับฝุ่นละออง แทรกซึมเข้าสู่ผิวหนังผ่านรูขุมขน สะสมจนผิวหนังไม่สามารถหายใจได้ และขาดการนำพาออกซิเจนเข้าสู่ผิวหนัง ส่งผลต่อการผลิตเปลี่ยนแปลงเซลล์ใหม่ให้ช้าลง ทำให้ผิวแห้งและหยابกร้าน ดูหมองคล้ำ

นี่คือนวัตกรรมใหม่ที่จะมาปฏิวัติการอาบน้ำให้สะอาดล้ำลึกในทุกอณูของผิวและซอกซอนลึกในทุกรูขุมขนจากผลการวิจัยค้นพบว่า ออกซิเจน ที่เข้าสู่ผิวหนังมีส่วนช่วยฟื้นฟูสภาพผิว ขจัดเซลล์ที่หมดสภาพ และช่วยสร้างเซลล์ผิวใหม่ ทำให้ผิวพรรณเนียนนุ่ม ชุ่มชื้น ดูอ่อนกว่าวัย

CRISTINA จึงได้คิดค้นเทคโนโลยีล้ำสมัย ด้วยการเติมออกซิเจนเข้าไปในน้ำฟองอากาศขนาดเล็กระดับ 5 ไมครอน ที่ถูกสร้างขึ้นส่งผลให้น้ำในอ่างเปลี่ยนเป็นสีขาวนวล คล้ายสีของน้ำนม ช่วยทำความสะอาดผิว ขจัดสารเคมี ฝุ่นละอองที่เกาะติดผิวหนัง และตามรูขุมขน ให้หลุดออกไปอย่างง่ายดาย ทำความสะอาดได้อย่างล้ำลึก พร้อมด้วยระบบ OZONE ที่ช่วยกำจัดเชื้อแบคทีเรีย ซึ่งเป็นวิธีธรรมชาติ ที่ปราศจากสารเคมี อย่างแท้จริง อีกทั้งการแตกตัว ของฟองอากาศนับล้านฟอง ก่อเกิดเป็นแอนไอออนที่ลอยอยู่เหนือผิวน้ำ การได้สัมผัสลมหายใจและน้ำละอองน้ำขนาดเล็กที่มีแอนไอออนเข้าไป จะทำให้ร่างกายได้รับออกซิเจนเพิ่มขึ้น ร่างกายจะรู้สึกผ่อนคลาย ซึ่งแอนไอออนนั้นมีอยู่ในธรรมชาติ และเราสามารถหาได้บริเวณน้ำตก ป่า หรือทะเลเท่านั้น แต่ด้วยความเข้าใจในกระบวนการธรรมชาติผสานกับเทคโนโลยีที่ล้ำสมัย ทำให้คุณสามารถสัมผัสธรรมชาติอันบริสุทธิ์นี้ได้ที่บ้านคุณ



OXYZKIN จะเป็นผู้ช่วยที่นำออกซิเจน เข้าสู่ผิวของคุณอีกครั้ง โดยฟองอากาศที่มีขนาดเล็กถึง ระดับ 5 ไมครอน มีขนาดเล็กกว่า รูขุมขนบนร่างกาย ออกซิเจนแทรกซึมเข้าไปทำความสะอาดได้อย่างล้ำลึก



## สะอาดล้ำลึก

ทุกรูขุมขน พลังการชำระล้างที่แทรกซึมทุกอณูของผิว



## กระตุ้น

การไหลเวียนของโลหิตส่งผลให้เกิดการสร้างเซลล์ผิวใหม่



## ฟื้นฟู

และปรับสภาพผิวหนังให้อ่อนนุ่ม ชุ่มชื้น มีชีวิตชีวาแลดูอ่อนกว่าวัย



## ปราศจากสารเคมี

สามารถใช้ได้กับทุกสภาพผิวแม้ผิวบอบบางแพ้ง่าย

# CRISTINA hybrid



## PERFORMANCE, GREENER, QUIETER

A Whole new world of benefits.



Less Energy Consumption



Than The Closest Competitor



Ambient Noise



Warmer Longer



### QUIETEST

Comparison Of Levels Of Noise (dB)

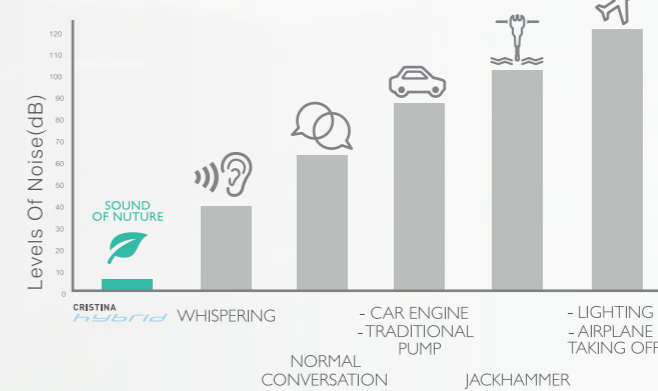

### HIGH-END PERFORMANCE

Water Flow @ 5psi / 12 ft of head  
(Gallons Per Minute)

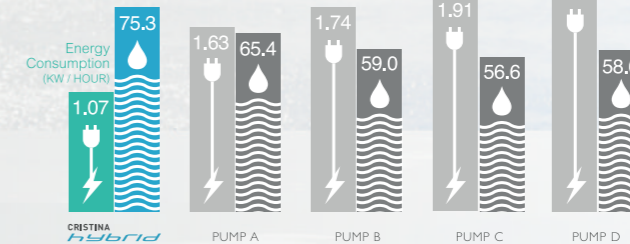

### WARMER LONGER

Cristina hybrid pump maintains constant water temperature

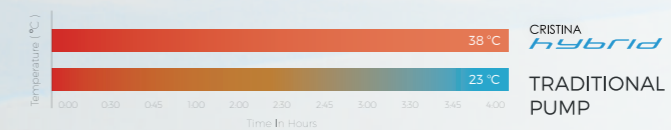

SOURCE : IAPMO - INTERNATIONAL ASSOCIATION OF PLUMBING AND MECHANICAL OFFICIALS

BATHTUB  
**CONTENTS**

NEW  
ARRIVAL

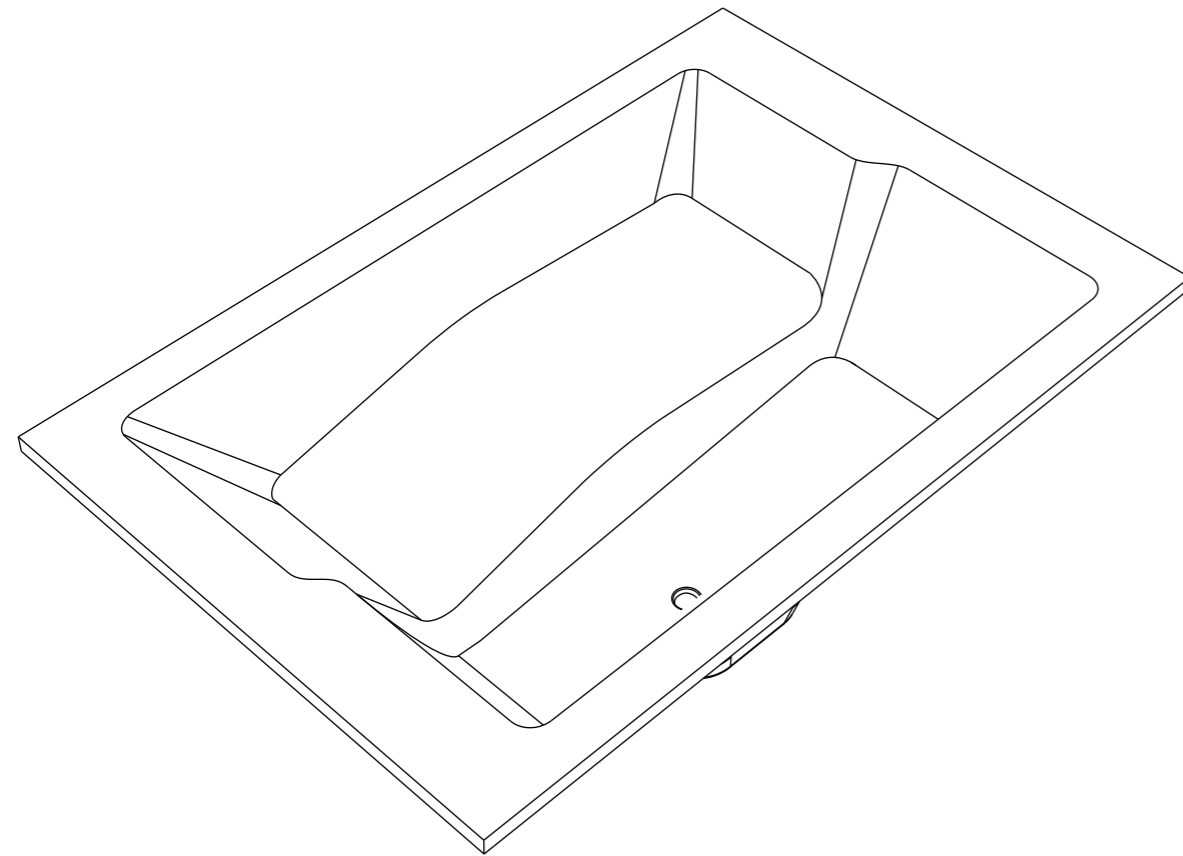

CARNIVAL 912



03 **OVERFLOW** SERIES



05 **SOAKING TUB** SERIES



07 **WATERFALL** SERIES

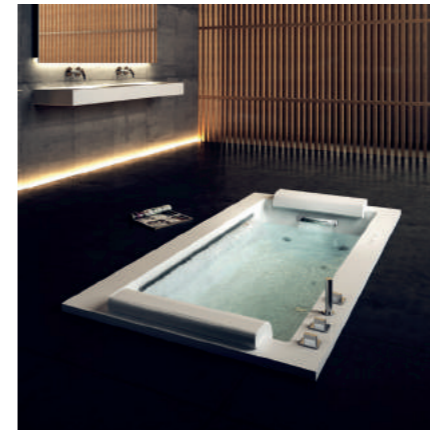

11 **WATERSHEET** SERIES



13 **FREESTAND** SERIES



17 **THE CONNECT** SERIES



19 **SCULPTURE** SERIES



23 **CORNER** SERIES



27 **VARIETY** SERIES



NEW ARRIVAL

**BELLA**  
1200 x 720 x 850 mm

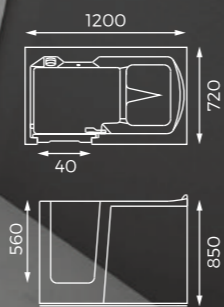

NEW ARRIVAL

**CARNIVAL 912**  
1900 x 1200 x 480 mm

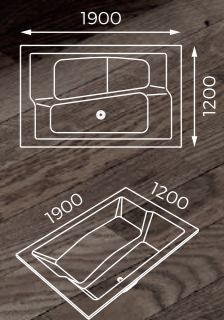

NEW ARRIVAL

**AWA**  
2000 x 1500 x 550 mm  
2100 x 1700 x 550 mm  
2100 x 1500 x 550 mm



NEW ARRIVAL

**CORNER WATERFALL 1**  
1900 X 1250 x 610 mm

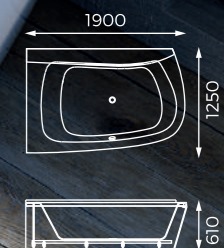

# OVERFLOW

Series



**LUZERN**  
2100 x 1500 x 450 mm.

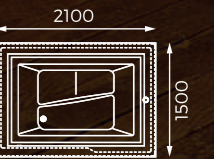

**LUZERN**  
Ø 2100 x 2100 x 450 mm.

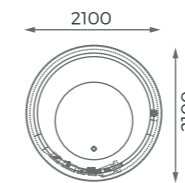

**LUZERN**  
2100 x 2100 x 450 mm.

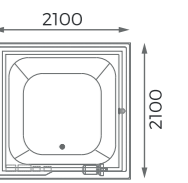

# SOAKING TUB

Series



**H2O**  
2000 x 2000 x 620 mm



**H2O**  
Ø 1800 x 620 mm

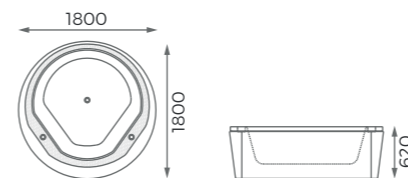

**H2O**  
2000 x 1100 x 620 mm

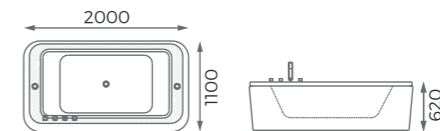

**H2O**  
2000 x 1500 x 620 mm

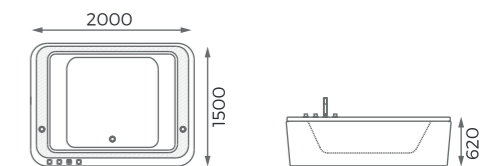

# WATERFALL

Series



**BEST  
SELLER**

## TAKIYU 190120

- 1700 x 1000 x 500 mm
- 1800 x 1100 x 500 mm
- 1900 x 1200 x 500 mm
- 1900 x 1400 x 500 mm
- 2000 x 1300 x 500 mm

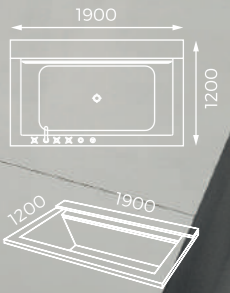

## TAKIYU 190100

- 1900 x 1000 x 500 mm

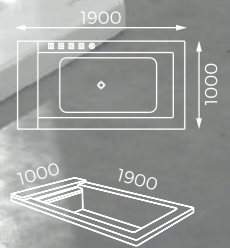





**TAKIYU 180180**  
1800 x 1800 x 500 mm



**TAKIYU 220140**  
2200 x 1400 x 500 mm  
2000 x 1400 x 500 mm



**TAKIYU 190140**  
1900 x 1400 x 550 mm

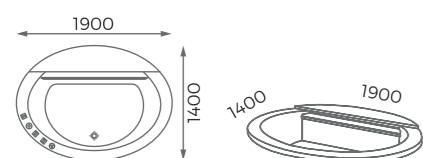

**TAKIYU 170000**  
Ø 1700 x 550 mm

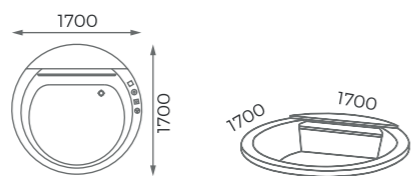

**TAKIYU 200120**  
2000 x 1200 x 550 mm

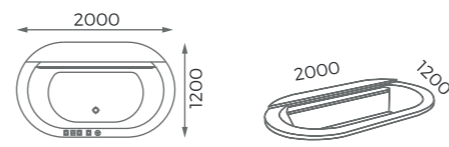

**TAKIYU 190150**  
1900 x 1500 x 500 mm

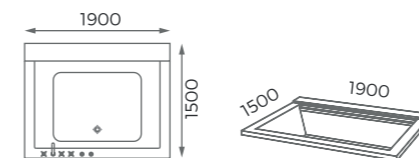

**TAKIYU 160160**  
1600 x 1600 x 500 mm

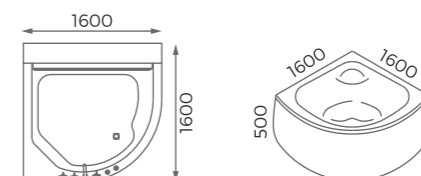

**TAKIYU TT**  
2000 x 1700 x 500 mm

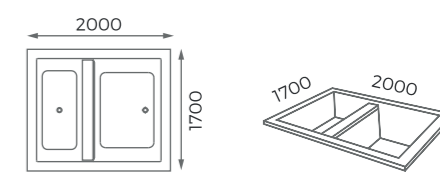

# WATERSHEET

Series



**ZPELL**  
1850 x 1050 x 470 mm.

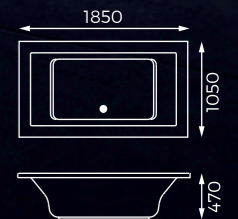

**ZPELL**  
1800 x 1300 x 500 mm  
1900 x 1300 x 500 mm  
2000 x 1300 x 500 mm

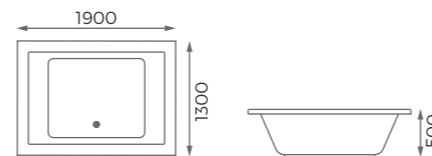

**ZPELL Z**  
2000 x 1300 x 490 mm

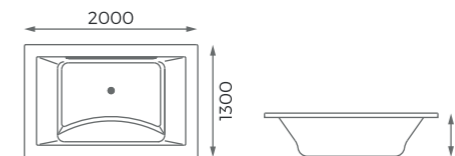

**SURF**  
2000 x 1200 x 450 mm

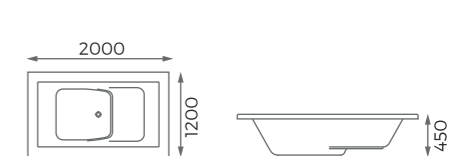

# FREESTAND

Series



**NOVA**  
1900 x 1300 x 620 mm



**NOVA**  
1900 x 1300 x 620 mm

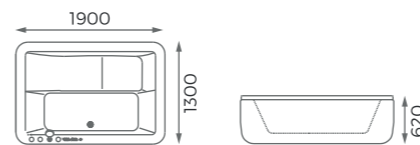

**SAFARI**  
1800 x 900 x 680 mm  
1900 x 1300 x 665 mm

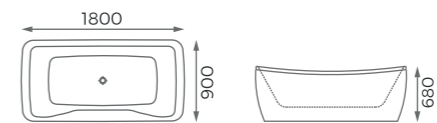

**CASA**  
1800 x 1050 x 620 mm

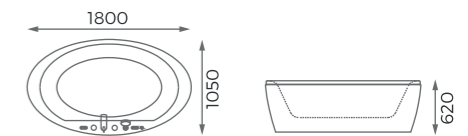

# ECOLUTION TECHNOLOGY



**QUIET BUT MORE POWERFUL WATER FLOW**

น้ำแรงขึ้น / ประหยัดพลังงาน / ไร้เสียงรบกวน

## "Minimal Momentum and Energy Loss"

BUILT-IN SUPA STELTH™

Allows the water to change direction to a far smoother passage for the water to flow.

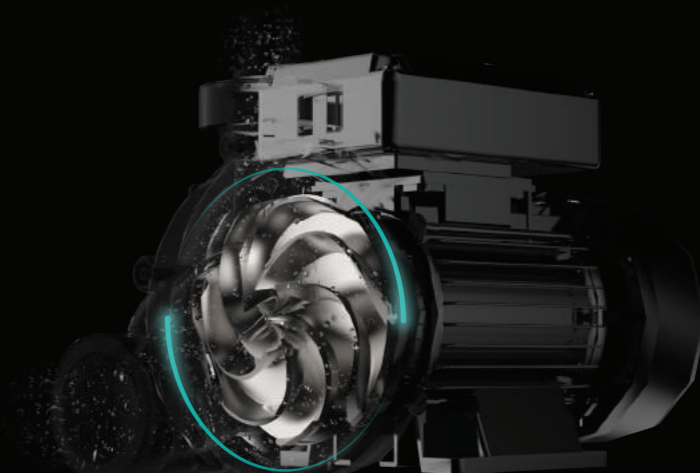

COMMERCIAL REFERENCE PUMPS  
น้ำปะทะเกิดเสียงดังและแรงดันน้ำน้อยลง

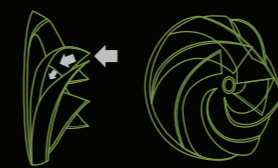

SUPA STELTH™  
ลดแรงเสียดทาน ทำให้น้ำแรงมากขึ้น





# THE CONNECT

Series



**PALOMA**  
2000 x 2000 x 570 mm

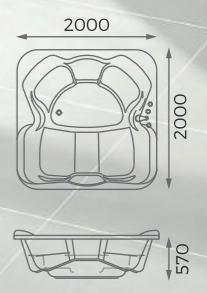

**SQUARE**  
1500 x 1500 x 450 mm

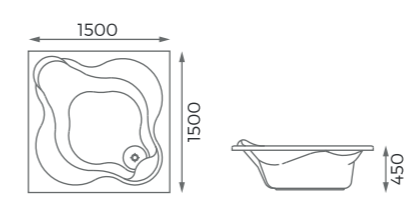

**ESSENCE**  
1750 x 1750 x 520 mm

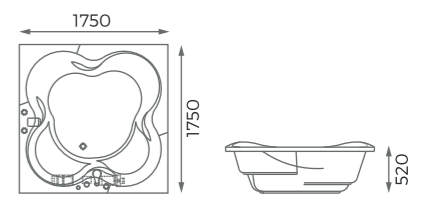

# SCULPTURE

Series



**REGEND**  
1700 x 750 x 780 mm

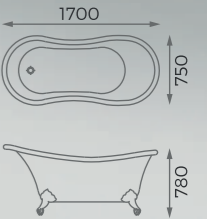

**PRESTIGE**  
1800 x 800 x 760 mm

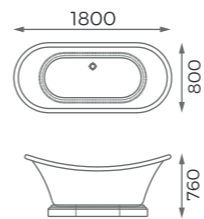

**SENZA**  
1700 x 800 x 590 mm

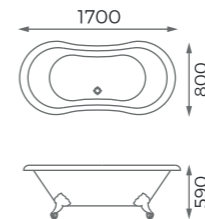

**EXCEL**  
1750 x 750 x 590 mm  
1700 x 700 x 570 mm

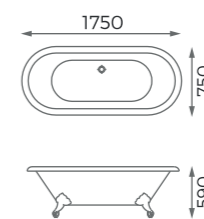

**KLASSE**  
1600 x 750 x 590 mm

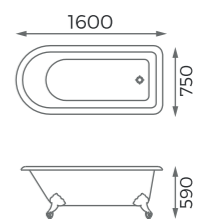



**TESLA**

1700 x 800 x 750 mm  
1800 x 800 x 750 mm

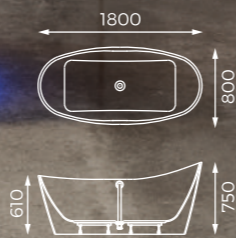

**CONRAD-C**

1670 x 780 x 580 mm

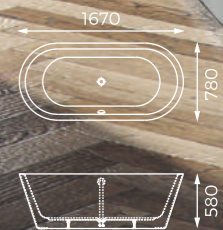

**COOL**

1700 x 800 x 600 mm

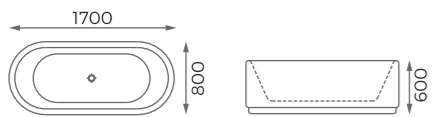

**PAYTAI**

1700 x 850 x 580 mm

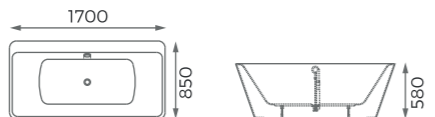

**HELIX**

1800 x 850 x 580 mm

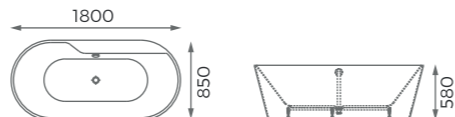

**ARK-C**

1500 x 820 x 695 mm

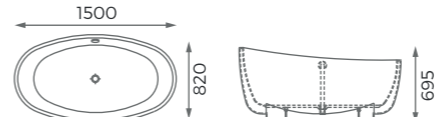

**OVUM**

1830 x 820 x 600 mm

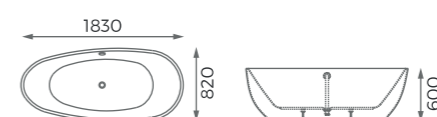

**VESSELA**

1680 x 870 x 670 mm

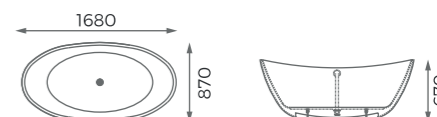

**CORNER**  
Series







**TOSCANA**  
1300 x 1300 x 620 mm.

**TIPTOP**  
1450 x 1450 x 620 mm.

**TUBBY**  
1200 x 1200 x 600 mm.

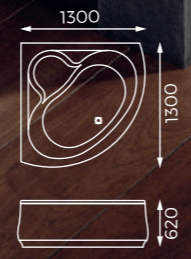

**JAKO**  
1500 x 1500 x 620 mm.

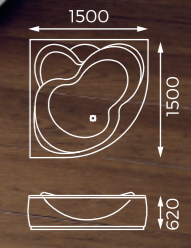

**ZOOM**  
1700 x 850 x 620 mm.  
1600 x 850 x 620 mm.

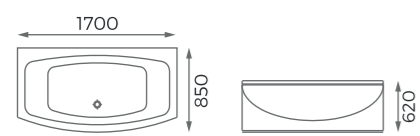

**LOGO**  
1700 x 850 x 620 mm.  
1800 x 900 x 620 mm.

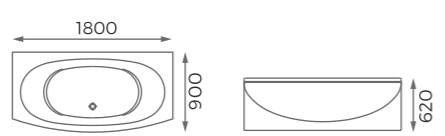

**VISA-R,L**  
1700 x 850 x 620 mm.

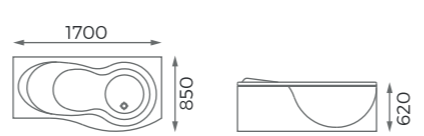

**KYOTO**  
1600 x 1600 x 620 mm.

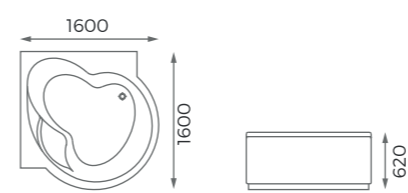

**SERRE**  
1450 x 1450 x 620 mm.

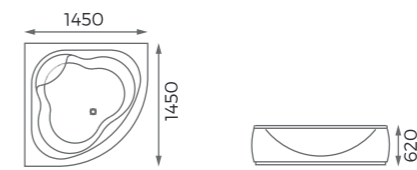

**KONI-R,L**  
1600 x 900 x 620 mm.

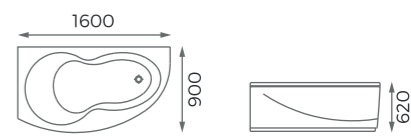



**VARIETY**  
Series



**CARNIVAL 213**  
2000 x 1300 x 500 mm

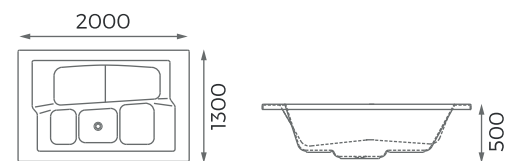

**AQUA COOL**  
1900 x 1500 x 550 mm

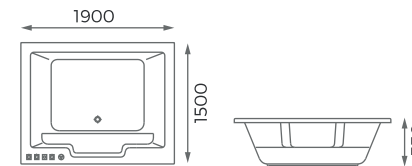

**REGAL**  
1900 x 1200 x 550 mm

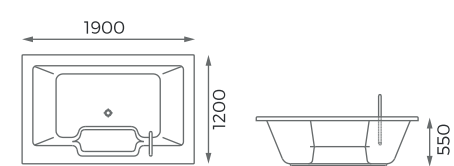

**AZURE**  
2000 x 1500 x 550 mm

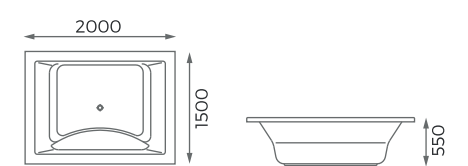

**LEISURE**  
1850 x 900 x 470 mm

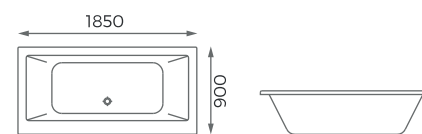

**CHAT**  
1800 x 900 x 480 mm

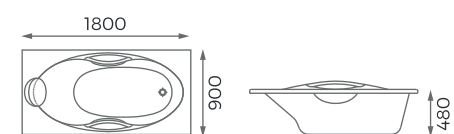

**BACIO**  
1900 x 1200 x 550 mm

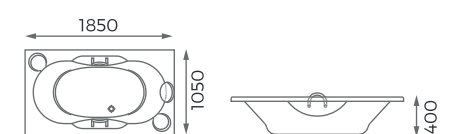



### CARNIVAL

A 2000 x 1200 x 460 mm  
B 1900 x 1200 x 460 mm

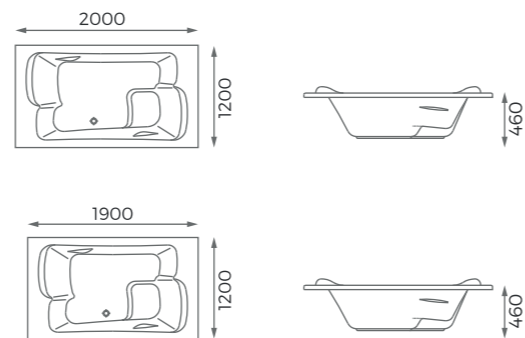

### NAGA

2000 x 1300 x 480 mm

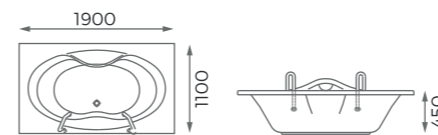

### NATURA

1200 x 750 x 410 mm

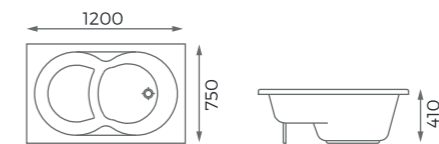

### PASTA

A 1500 x 700 x 420 mm  
B 1400 x 700 x 420 mm



### TARA

1600 x 700 x 400 mm  
1700 x 700 x 400 mm  
1700 x 800 x 400 mm



### TEENA

1600 x 750 x 380 mm    1700 x 750 x 380 mm  
1600 x 700 x 380 mm    1700 x 700 x 380 mm



### NAPOLI

1700 x 800 x 450 mm

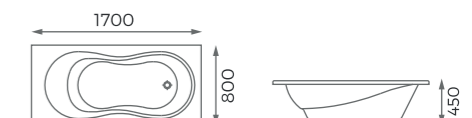



**BORABORA**

1800 x 1300 x 500 mm  
 1900 x 1300 x 500 mm  
 2000 x 1300 x 500 mm

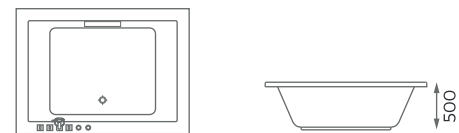

**MAX**

1500 x 700 x 430 mm      1700 x 800 x 460 mm  
 1500 x 750 x 430 mm      1750 x 850 x 460 mm  
 1600 x 700 x 430 mm      1800 x 800 x 460 mm  
 1600 x 750 x 430 mm      1800 x 900 x 460 mm  
 1700 x 750 x 430 mm



**X-TREME**

1500 x 700 x 460 mm      1700 x 800 x 460 mm  
 1500 x 750 x 460 mm      1700 x 850 x 460 mm  
 1600 x 700 x 460 mm      1800 x 800 x 460 mm  
 1600 x 750 x 460 mm      1800 x 900 x 460 mm  
 1700 x 750 x 460 mm



**LIFE**

1850 x 1100 x 550 mm

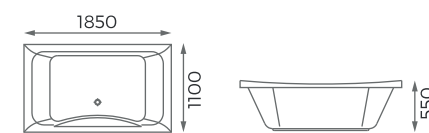

**ONE**

1900 x 900 x 500 mm

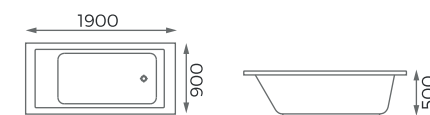

**TATA**

2000 x 1200 x 550 mm

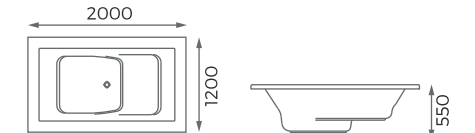



**ROMA**  
 Ø 1700 x 1700 x 480 mm

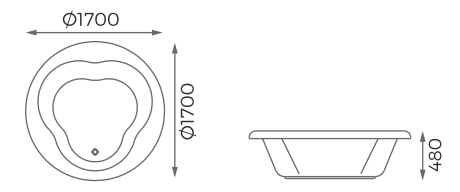

**BARI**  
 1850 x 1100 x 550 mm

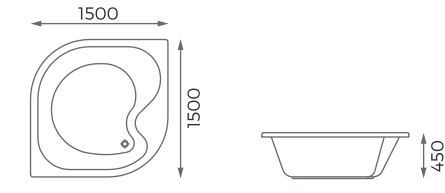

**OPEN**  
 1800 x 1200 x 450 mm

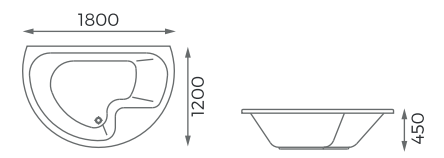

**KIKI**  
 1600 x 1600 x 480 mm

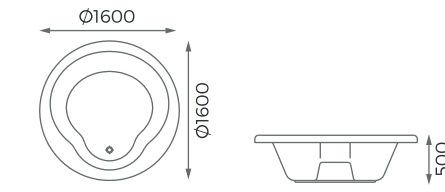

**RADIUS**  
 1800 x 1800 x 500 mm

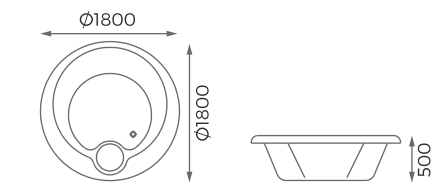



**SELECT**  
1800 x 900 x 600 mm

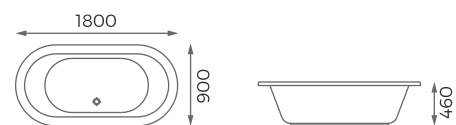

**SEASON**  
1850 x 900 x 470 mm

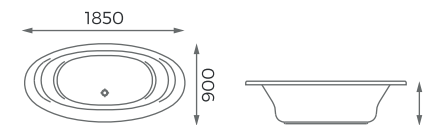

**CANOVA**  
1800 x 1000 x 490 mm

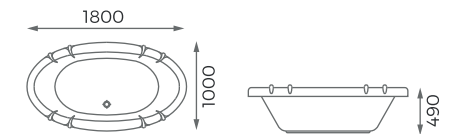

**FLASH**  
1800 x 900 x 420 mm

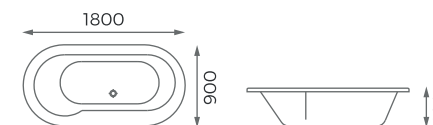

**BELLE**  
1850 x 950 x 470 mm

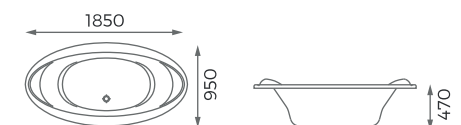

# CHROMOTHERAPY

bath with color to empower your life

with the need of inspiring your bathing experience with the great results of revitalization in a modern style and easy spa therapy CRISTINA proudly presents an underwater LED light system to make chromotherapy in your home.

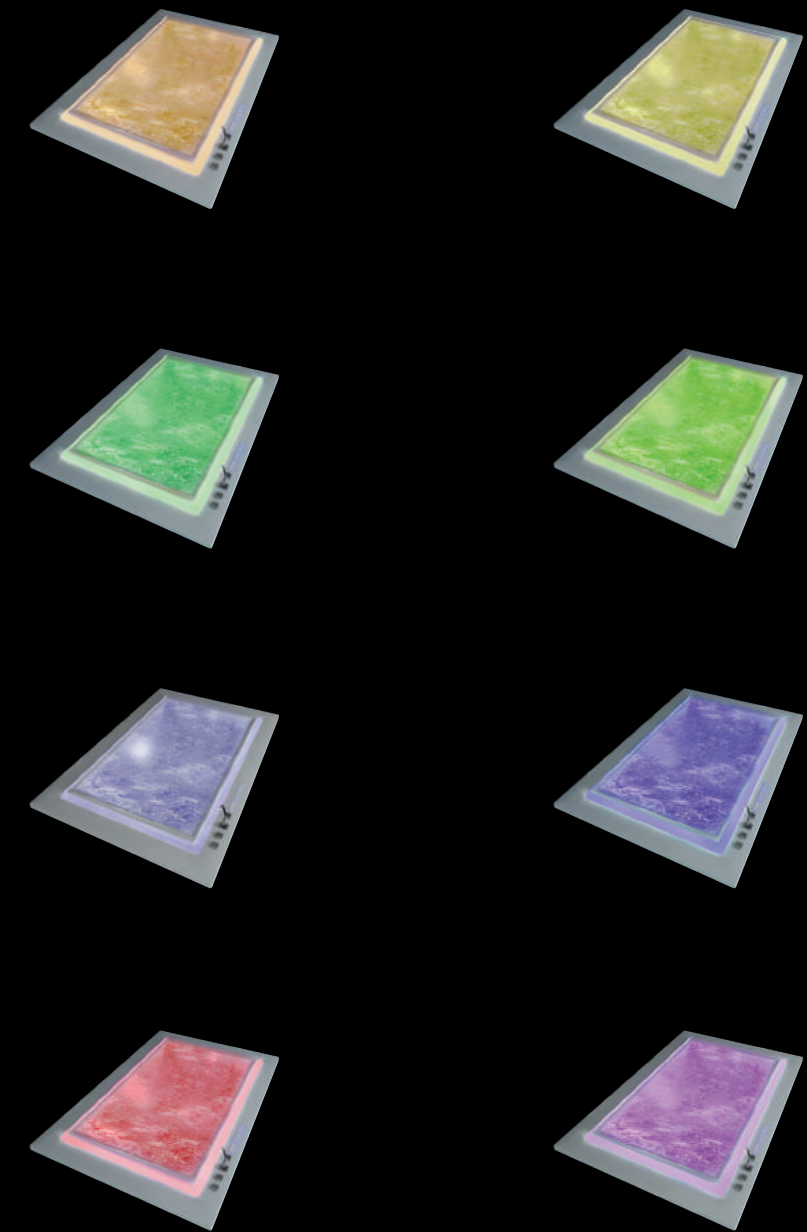

Due to a variety of spectrum ranges that CRISTINA has innovation of 10 colours, and the users are able to captivate any colour they desire while soaking their body in the tub. Each colour empowers the user with it's own particular treatment quality. CRISTINA provide 2 practical systems of control as alternatives in usage, the digital and pneumatic.



# WHIRLPOOL & AIRPOOL SYSTEM

In CRISTINA whirlpools, you can do more than just bathing. Relax and take time to enjoy the therapeutic feeling of water, which soothes away. Most of our luxurious baths can be fitted with a Whirlpool, Airpool or whirlpool + Airpool so you needn't settle for just an ordinary bath. Inquire our showroom technician as to the unit of your choice, if it could be equipped with any kind system.

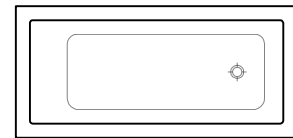

Bathtub  
(BT)

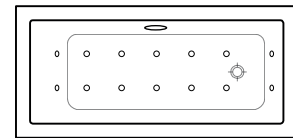

Airpool System  
(AP)

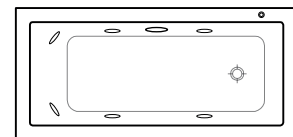

Whirlpool System  
(WP)

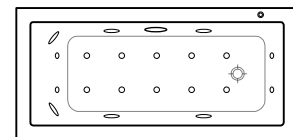

Whirlpool & Airpool System  
(WA)

## CIRCUIT BREAKER

All our whirlpool baths are fitted with actual circuit breaker, and a secure grounded earth for your protection

- UL listed 220 volt, 50Hz.
- Fully automated tripping
- Complete with a sensitivity rating 30 milliamperes.
- With only one tenth of a second trip.

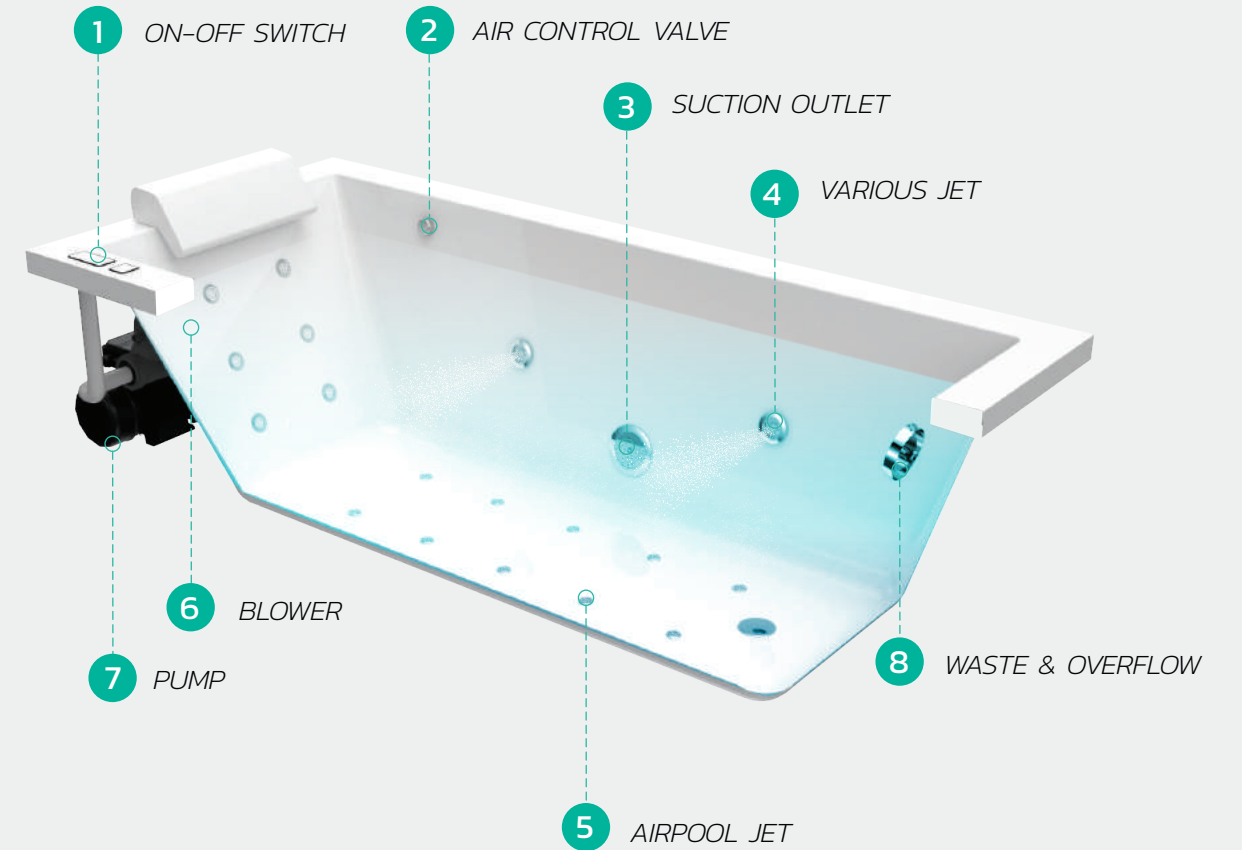

### 1 ON-OFF SWITCH

- Conveniently located and completely waterproof.
- Designed with allow profile to please the eye
- With two diameters : 4.25 cm. ,6.5cm.

### 2 AIR CONTROL VALVE

- A standard fitment which allows you to adjust the air/water mixture, so it's just right for your own personal use.

### 3 SUCTION OUTLET

- Side mounted incorporating a anti vortex design
- ABS or chrome plate brass
- Component diameters : 9.5 cm. and 10.5 cm.

### 4 VARIOUS JET

- Micro Jet
- Standard Jet
- Whirlpool
- Mini Rotary Jet

### 5 AIRPOOL JET

- Chrome - plated
- Flush inset design
- No water backflow
- Fixture diameter : 3.0 cm.

### 6 BLOWER

- Quiet running
- 220 volt, 50 Hz.

### 7 PUMP

- Self-draining
- UL listed, 220 volt, 50 Hz.

### 8 WASTE & OVERFLOW

CRISTINA

**CRISTINA SANITARY (THAILAND) CO.,LTD.**

1556 SUTTHISANWINICHAI RD., HUAY KWANG  
BANGKOK, THAILAND.

**TEL** +66(2) 693 4046-9, **FAX** +66(2) 693 0430

**[WWW.CRISTINA.CO.TH](http://WWW.CRISTINA.CO.TH)**