

FRANKE

Collection 2022-2023



Collection 2022-2023





Collection 2022-2023

The Collection 10 - 17

Mythos / Maris / Smart

Inspirations 18 - 23

Sink 24 - 57

Tap 58 - 67

Hob 68 - 79

Hood 80 - 91

Oven 92 - 97

Microwave oven 98 - 99

Dishwasher 100 - 105

Waste disposer 106 - 109

Accessory 110 - 113

Over one hundred years of passion

Making something wonderful rarely happens overnight, and Franke has been pushing the boundaries for over 100 years. Founded in 1911, Franke was built on a foundation of precision engineering combined with traditional craftsmanship. Over 100 years later, those principles endure, while a focus on the changing needs and lifestyles of our customers has helped us become the world's largest manufacturer of kitchen sinks.

Swiss precision engineering

The Franke story began as a small sheet-metal business in Rorschach, Switzerland, established by Hermann Franke in 1911. Since then we've established efficient and economic manufacturing facilities all around the world.

Many things have changed in the past century, but what is always the same is a set of values, characterised by respect, trust and openness. The values of innovation, entrepreneurship, quality and stylish design were in the heart of Hermann Franke and continue to be at the heart of the business, as we enter a second century of smart and stunning design.





FRANKE HOME SOLUTIONS

Complete solutions for your kitchen



The kitchen is a place where we love to spend time. It has always been a space for coming together. This emotional connection to the kitchen is the inspiration behind Franke's decision to design this room as an intelligent system, combining all the appliances involved in food preparation: from the sink to the hood to the waste separation solutions. Franke offers integrated systems that lend both style and functionality to your kitchen. Our goal is for you to be able to enjoy cooking, eating

and simply spending time in a kitchen that is equipped with Franke products. Like all high-end manufacturers of kitchen products, Franke is driven by core values such as design, quality, functionality and discipline. The company boasts 100 years of experience and expertise, championing innovation in order to offer products that are always perfectly suited to your needs.

Be inspired by our innovative solutions for your kitchen!



Appliances

Ovens, microwaves, hobs, fridges and dishwashers.

Discover our new range of appliances: Ovens, microwaves, induction hobs, plate warmers and built-in coffee machines!



Food preparation area

Sinks, basins, taps, taps with water filtration technology, soap dispensers, waste management and kitchen accessories.



Hoods

A wide range of hoods designed to be integrated into ceilings, islands and cooktops, decorative versions, built-in and extractable models.

FRANKE HOME SOLUTIONS

The Collection

Research and continuous innovation. Authentic materials and colours. Harmonious shapes brimming with character. A range of new products created to improve life in the kitchen, including mixer taps, sinks, hoods, hobs and ovens. All of this is at the heart of Franke's collections. Mythos, for all those who love design and elegance. Maris, for a safe, cosy kitchen that is perfect for families. Smart, for a simple, functional and modern kitchen environment. As of today, cooking with Franke is set to become even more enjoyable!

Mythos

A passion for details

An elegant, timeless kitchen. A unique, unforgettable style. The Mythos collection never fails to impress, not only due to its refined design and the perfect combination of stainless steel and dark glass, but also thanks to its performance and the high quality it offers.



Maris

Family in the kitchen

Cooking together has never been this simple: the way the spaces are organised with Maris maximises the possibilities for sharing your culinary passion with your loved ones. All elements offer enhanced comfort and excellent durability: a space for the whole family.



Smart

Your kitchen, your way

Sharing an apartment with friends, or enjoying life as a young couple? It's a joy to spend time in the kitchen, particularly when it is such a perfect reflection of who you are. The Smart range satisfies each and every requirement in an original way with an expert blend of styles and materials, and integrates multifunctional components in a simple, intuitive manner.





Mythos

When cooking becomes art

A space which celebrates beauty in its purest form. Elegant lines, sophisticated materials and the very best performance. Mythos is all of this and more: the perfect synthesis of cutting-edge technology and design, marrying classic and contemporary style.

A collection for enthusiasts with exacting standards, it features pure, clean lines that embrace and enhance the robustness of the materials shaped by a design that expresses astonishing creativity.







Maris

A space for the whole family

Robust, durable materials. Each element is organised according to a highly functional approach. Maris is designed for sharing, and for spending time together as a family.

A free, open space which enables everyone to move around in total safety, united by the continuity of the surfaces in a kitchen system that can be configured in accordance with your wishes.





Smart

Simple, functional and modern

Intelligent, highly functional equipment. An optimal use of space. A fresh, modern design which enables different styles to be combined, with tasteful yet original results.

The Smart collection is designed for ease of use, and can be adapted to suit any environment. Each functional element contributes to the beautiful simplicity of the space, in perfect harmony with today's requirements.





“ We believe that sustainability means fairness to future generations”

Shaping our future

Preserving the environment – shaping the future: As a company conscious of our responsibilities, we think and act today in the interests of the world of tomorrow. We work hand in hand with our partners, customers and suppliers to create a liveable future where people can also thrive.

“We believe that sustainability means fairness to future generations” – this quote from Michael Pieper, owner of the Franke Group encapsulates our company ideals. We reconcile economics and ecology and make a proactive contribution towards sustainable development – with long-lasting products, recyclable materials and smart technologies. We use the global sustainable development goals and the United Nations Global Compact (UNGC) as a guide and framework on the path to a climate-neutral future.

Putting people at the heart of our sustainability

The foundation of our new sustainability strategy rests on the three pillars of the environment, employees and the company. When it comes to environment, we focus on the production and lifecycles of our products. As the market leader, creating reliable and innovative solutions with real added value is both a challenge and a source of motivation.

This exceptional quality enables customers to use our products for more than two decades – conserving resources in the process.

We also feel an immense responsibility towards our employees, of which there are approximately 8700 around the world. Words like appreciation and trust aren't just empty phrases to us, they're deeply embedded in our company's DNA.

We help people to stay healthy and to make their professional aspirations a reality. Franke is synonymous with diversity, equal opportunities, cohesion and a company culture where people want to give their best and contribute their own ideas.

Good for everyone!

Good for our partners and customers. Good for the planet. Good work. We believe that sustainability means planning ahead. We see environmental action as an opportunity and this attitude is also reflected in Franke's products.



Less plastic and better taste

No packaging, no waste, no distance travelled: Drinking tap water uses significantly fewer environmental resources than mineral or carbonated water. Plastic bottles have a particularly stark effect on the environment – around the world, over 1500 bottles end up in the sea every second. It doesn't have to be this way. With our Vital filter tap, you can transform tap water into delicious water to drink. In the smallest of spaces, the capsule filter combines activated carbon and a high-tech membrane to reliably remove bacteria, viruses, microplastic, rust, medication residues and hormones. Customers are therefore guaranteed clean drinking water which is equally good for their health and the environment.



Saving water has never been so easy

Another star in Franke's range of products is the Atlas Neo Sensor. This innovative technology allows you to switch the water flow off and back on again even when your hands are covered with soap – in a completely touch-free system. This saves around three litres of water every time you wash your hands and keeps the tap spotless. The sensor will switch off automatically after 30 seconds. Needless to say, you can still operate the tap manually.



Clean air for maximum energy efficiency

Our extractor hobs offer maximum energy efficiency. For example, the extremely powerful Mythos 2gether extractor hob is classed in the best possible energy efficiency rating A+++ thanks to its innovative and brushless motor.



Quality above all else

Visually appealing, functional in use, steel represents our kitchen ideas.

The sheer quality of Franke products can be seen and felt. We use AISI 304 18/10 steel, which is produced in Italy and Europe: a choice that reflects our dedication to quality, one of our core priorities over the 100-plus years of our history.

Strong and robust, Franke steel ensures that our products maintain their functionality over time.

Its extraordinary brilliance is captivating and striking, making it the defining feature of the living spaces in which it is installed.

Its superb technical features ensure that it is always in demand, and highly appreciated by professionals in the haute cuisine sector: furthermore, stainless steel is an extremely hygienic material, and is easy to clean and recyclable. Aesthetically pleasing and functional to use: stainless steel is at the heart of our kitchen concept.

Durable

The specific concentrations of nickel and chrome in AISI 304 18/10 steel render it particularly resistant to extreme temperatures. Its brilliance does not fade over time; on the contrary, its beauty and appeal only increase.

Functional

Steel is the material of choice for kitchen professionals, due to the fact that it is resistant, hygienic and safe. Its non-porous surface is extremely easy to clean.

Easy to maintain

Steel is easy to maintain; just a few simple daily steps ensure that it remains a joy to use over time. Skip to the next page for tips on how to take care of Franke steel.



Caring for Franke steel

While steel is environmentally friendly, 100% recyclable, durable, easy to clean and very hygienic, it is nonetheless easy to scratch. Below are a few guidelines for taking care of 18/10 stainless steel over time.

To keep stainless steel in good condition, it is a good idea to clean it daily using soap and water or a neutral detergent, wiping down the surface with a soft sponge or microfibre cloth.

Always thoroughly rinse and dry the sink after every use, particularly in hard water areas. When cleaning and drying, always ensure that you move in the direction of the satin finish.

If limescale stains appear, these can be cleaned using a simple solution of 1/4 white vinegar with 3/4 hot water, following the steps above.

We also recommend using detergents specifically designed for taking care of stainless steel; always read the instructions for use and follow the dosage indicated on the label.

Franke has developed its Kitchen Care range to meet all steel maintenance needs; these products are specifically developed for the daily care of sinks and all other steel elements.







Stainless Steel Sink

MYTHOS SINK

The joy of precision





With our new sink range, everything runs smoothly. With flawless features and contemporary detail, these sinks will add a special touch to your kitchen area. If you are looking for a minimalist and sophisticated bowl, the new Mythos range will seamlessly fit your needs. THE JOY OF PRECISION Precise and elegant in style, this premium range will complement those with a flair for contemporary and minimalist design. With a tighter bowl radius, 6 mm rim and a flush waste cover, Mythos is sure to integrate seamlessly into your kitchen area and brings everything a modern cook requires: attention to detail and absolute elegance.



The perfect rim

The new Franke sinks are designed and manufactured with the highest precision. The unique 6 mm rim perfectly integrates the sink into the worktop.

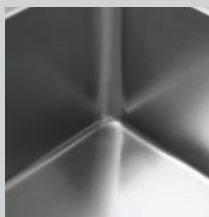

Perfectly rounded corners

The bowls' corner radius creates a smoother shape within the bowl which makes it less high-maintenance and easier to clean.



Seamless waste cover

The stylish cover sits flush over the waste and fits elegantly into the sink, making it much easier to clean.

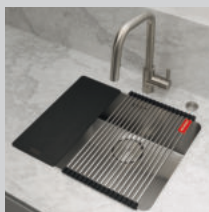

Accessories

The Mythos bowl makes cooking and food-preparation more exciting. Everything is perfectly organized. The accessories are beautifully crafted and simplify all the jobs in the kitchen.



MYX 120-34-34 Mythos

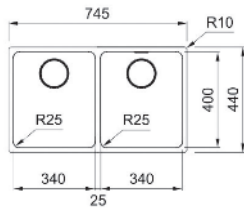

Master FUN Number
122.0603.117

Material **SS 304**
Type/Installation **Undermount**
Number of Bowls **2**
Exterior Dimension (mm) **745W 440D**
Bowl 1 Dimensions (mm) **340W 400D 200H**
Bowl 2 Dimensions (mm) **340W 400D 200H**
Cut-Out Size (mm) **Upon request**

Price :
79,900 .-
Special Price :
55,500 .-

Special Order

MYX 210-55 Mythos

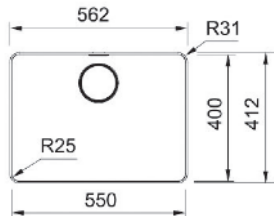

Master FUN Number
127.0603.519

Material **SS 304**
Type/Installation **Flushmount**
Number of Bowls **1**
Exterior Dimension (mm) **562W 412D**
Bowl 1 Dimensions (mm) **550W 400D 200H**
Cut-Out Size (mm) **Upon request**

Price :
79,900 .-
Special Price :
55,500 .-

Included Accessories



Paperstone Slate Chopping board
112.0591.082
412 x 180 (mm.)

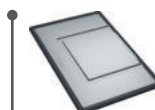

Stainless Steel/Synthetic Mobile Drainer
112.0602.288
412 x 298 x 17 (mm.)



Stainless Steel Strainer Bowl
112.0659.398
416 x 158 x 54 (mm.)



Stainless Steel/Synthetic Rollmatt
112.0591.081
424 x 267 (mm.)

MYX 110-70 Mythos

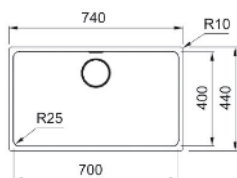

Master FUN Number
122.0601.312

Material **SS 304**
Type/Installation **Undermount**
Number of Bowls **1**
Exterior Dimension (mm) **740W 440D**
Bowl 1 Dimensions (mm) **700W 400D 200H**
Cut-Out Size (mm) **Upon request**

Price :
55,900 .-
Special Price :
45,900 .-

Special Order

Stainless Steel Sink

MYX 110-55 Mythos

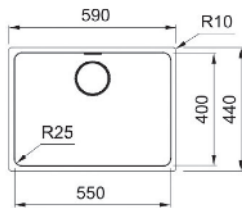

Master FUN Number
122.0600.947

Material **SS 304**
Type/Installation **Undermount**
Number of Bowls **1**
Exterior Dimension (mm) **590W 440D**
Bowl 1 Dimensions (mm) **550W 400D 200H**
Cut-Out Size (mm) **Upon request**

Price :
52,900 .-

Special Price :
42,900 .-

Special Order

MYX 110-45 Mythos

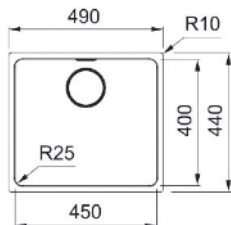

Master FUN Number
122.0600.935

Material **SS 304**
Type/Installation **Undermount**
Number of Bowls **1**
Exterior Dimension (mm) **490W 440D**
Bowl 1 Dimensions (mm) **450W 400D 200H**
Cut-Out Size (mm) **Upon request**

Price :
51,500 .-

Special Price :
41,000 .-

Special Order



BWX 220-54-27 WCR Box Center



Master Fun Number
127.0538.259

Material **SS 304**
 Type/Installation **Inset/Flushmount**
 Number of Bowls **2**
 Exterior Dimension (mm) **860W 510D**
 Bowl 1 Dimensions (mm) **540W 410D 200H**
 Bowl 1 Dimensions (mm) **270W 480D 200H**
 Cut-Out Size (mm) **Upon request**

Price :
68,500 .-

Special Price :
55,900 .-

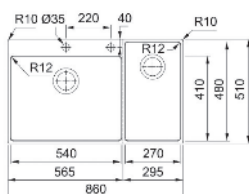

Included Accessories
112.0588.226

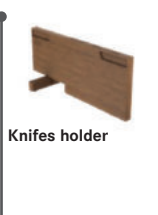
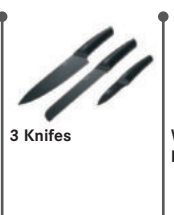



PPX 120 Planar

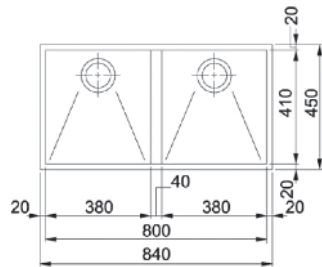

Master FUN Number
122.0198.205

Material **SS 304**
Type/Installation **Undermount**
Number of Bowls **2**
Exterior Dimension (mm) **840W 450D**
Bowl 1 Dimensions (mm) **380W 410D 200H**
Bowl 2 Dimensions (mm) **380W 410D 200H**
Cut-Out Size (mm) **Upon request**
Pop-up

Price :
50,900 .-
Special Price :
40,900 .-

PPX 220B* Planar

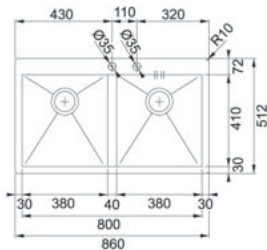

Master FUN Number
127.0198.194

Material **SS 304**
Type/Installation **Inset/Flushmount**
Number of Bowls **2**
Exterior Dimension (mm) **860W 512D**
Bowl 1 Dimensions (mm) **380W 410D 200H**
Bowl 2 Dimensions (mm) **380W 410D 200H**
Cut-Out Size (mm) **Upon request**
Pop-up

Price :
53,900 .-
Special Price :
43,900 .-

PPX 211 Planar

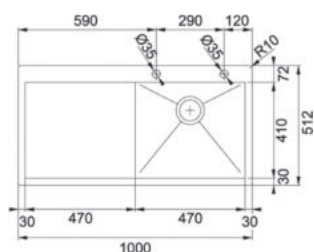

Master FUN Number
127.0203.465/LHD
127.0203.464/RHD

Material **SS 304**
Type/Installation **Inset/Flushmount**
Number of Bowls **1**
Exterior Dimension (mm) **1000W 512D**
Bowl 1 Dimensions (mm) **470W 410D 200H**
Cut-Out Size (mm) **980W 492D**
Pop-up

Price :
44,900 .-
Special Price :
34,900 .-

Stainless Steel Sink

PPX 210-78 B Planar

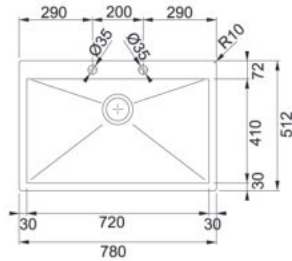

Master FUN Number
127.0198.197

Material **SS 304**
Type/Installation **Inset/Flushmount**
Number of Bowls **1**
Exterior Dimension (mm) **780W 512D**
Bowl 1 Dimensions (mm) **720W 410D 200H**
Cut-Out Size (mm) **Upon request**
Pop-up

Price :
50,900 .-

Special Price :
40,900 .-

PPX 110-72 Planar

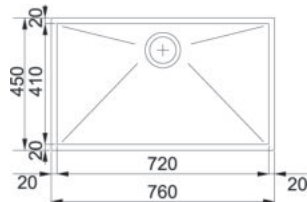

Master FUN Number
122.0198.208

Material **SS 304**
Type/Installation **Undermount**
Number of Bowls **1**
Exterior Dimension (mm) **760W 450D 200H**
Bowl 1 Dimensions (mm) **720W 410D 200H**
Cut-Out Size (mm) **Upon request**
Pop-up

Price :
48,500 .-

Special Price :
38,500 .-

AEX 610-A* Acquario Line

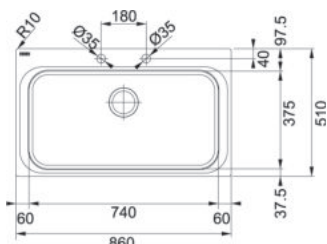

Included Accessories



Synthetic Chopping Board
112.0199.087
426 x 200 (mm)



Drainer Basket
112.0199.083
330 x 370 x 193 (mm)



Strainer Bowl
112.0199.085
300 x 340 (mm)



Drainer Tray
112.0199.086
366 x 406 (mm)

Master FUN Number
101.0199.089

Material **SS 304**
Type/Installation **Inset**
Number of Bowls **1**
Exterior Dimension (mm) **860W 510D 220H**
Bowl 1 Dimensions (mm) **740W 375D 220H**
Cut-Out Size (mm) **840W 490D**
Pop-up

Price :
38,900 .-

Special Price :
29,900 .-

BCX 610-81 Bell



Master FUN Number
101.0393.025

Material **SS 304**
Type/Installation **Inset**
Number of Bowls **1**
Exterior Dimension (mm) **810W 510D**
Bowl 1 Dimensions (mm) **745W 445D 200H**
Cut-Out Size (mm) **786W 486D**

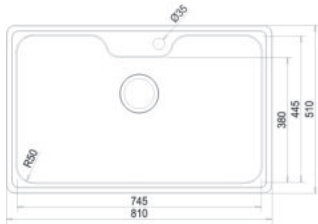

Included Accessories



Wooden Chopping Board
112.0437.910
465 x 220 x 18 (mm.)



Strainer Bowl
112.0437.932
200 x 400 x 85 (mm.)



Drainer Basket
112.0504.639
300 x 358 x 100 (mm.)

Price :
11,900 .-
Special Price :
8,390 .-

BCX 610-74 Bell



Master FUN Number
101.0649.613

Material **SS 304**
Type/Installation **Inset**
Number of Bowls **1**
Exterior Dimension (mm) **740W 480D**
Bowl 1 Dimensions (mm) **675W 350-415D 200H**
Cut-Out Size (mm) **Upon request**

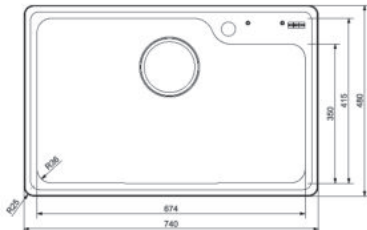

Included Accessories



Wooden Chopping Board
112.0505.218
435 x 220 x 23 (mm.)



Stainless Steel Rack
112.0591.898



Stainless Steel Drainer Basket
112.0561.410
430 x 220 x 170 (mm.)

Price :
13,800 .-
Special Price :
10,500 .-

NEX 221* Neptune



Master FUN Number
127.0059.718 /RHD

Material **SS 304**
Type/Installation **Inset/Flushmount**
Number of Bowls **2**
Exterior Dimension (mm) **1164W 514D 200H**
Bowl 1 Dimensions (mm) **360W 420D 200H**
Bowl 2 Dimensions (mm) **360W 420D 200H**
Cut-Out Size (mm) **988W 498D**

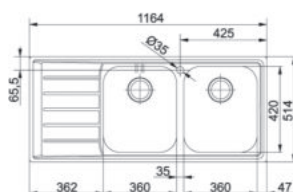

Price :
22,000 .-
Special Price :
16,900 .-

Stainless Steel Sink

OYX 220-86* Onyx

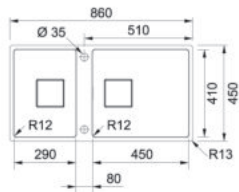
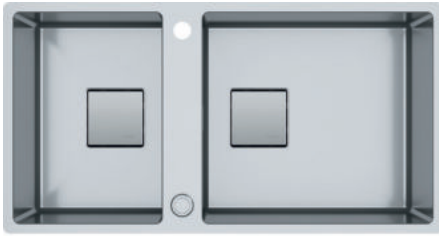

Master FUN Number
127.0577.582

Material **SS 304**
Type/Installation **Inset/Flushmount/Undermount**
Number of Bowls **2**
Exterior Dimension (mm) **860W 450D**
Bowl 1 Dimensions (mm) **450W 410D 200H**
Bowl 2 Dimensions (mm) **290W 410D 200H**
Cut-Out Size (mm) **Upon request**
Pop up

Price :
27,900 .-
Special Price :
20,900 .-

OYX 211-86* Onyx

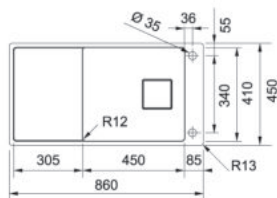

Master FUN Number
127.0607.603

Material **SS 304**
Type/Installation **Inset/Flushmount/Undermount**
Number of Bowls **1**
Exterior Dimension (mm) **860W 450D**
Bowl 1 Dimensions (mm) **450W 410D 200H**
Cut-Out Size (mm) **Upon request**
Pop up

Price :
19,000 .-
Special Price :
14,900 .-

OYX 210-45* Onyx

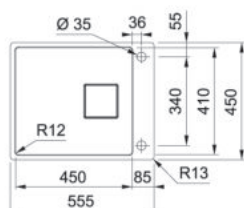
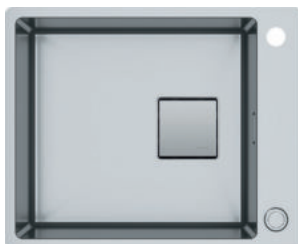

Master FUN Number
127.0577.479

Material **SS 304**
Type/Installation **Inset/Flushmount/Undermount**
Number of Bowls **1**
Exterior Dimension (mm) **555W 450D**
Bowl 1 Dimensions (mm) **450W 410D 200H**
Cut-Out Size (mm) **Upon request**

Price :
14,900 .-
Special Price :
11,900 .-

PZX 110-79 Planar

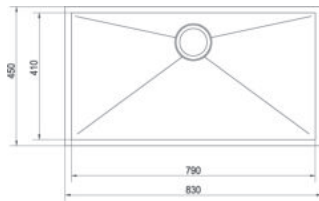

Master FUN Number
122.0180.820

Material **SS 304**
Type/Installation **Undermount**
Number of Bowls **1**
Exterior Dimension (mm) **830W 450D 200H**
Bowl 1 Dimensions (mm) **790W 410D 200H**
Cut-Out Size (mm) **Upon request**

Price :
22,000 .-
Special Price :
16,900 .-

PZX 110-54 Planar

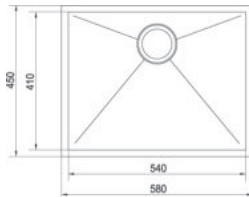

Master FUN Number
122.0183.184

Material **SS 304**
Type/Installation **Undermount**
Number of Bowls **1**
Exterior Dimension (mm) **580W 450D 200H**
Bowl 1 Dimensions (mm) **540W 410D 200H**
Cut-Out Size (mm) **Upon request**

Price :
17,900 .-
Special Price :
13,900 .-

PZX 610-39* Planar

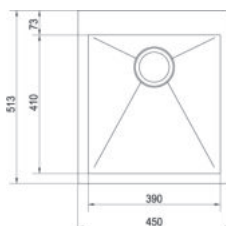

Master FUN Number
101.0364.415

Material **SS 304**
Type/Installation **Inset**
Number of Bowls **1**
Exterior Dimension (mm) **450W 513D 200H**
Bowl 1 Dimensions (mm) **390W 410D 200H**
Cut-Out Size (mm) **430W 490D**

Price :
12,900 .-
Special Price :
9,990 .-

Stainless Steel Sink

PZX 110-39 Planar

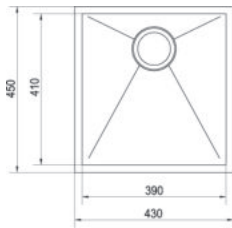

Master FUN Number
122.0309.379

Material **SS 304**
Type/Installation **Undermount**
Number of Bowls **1**
Exterior Dimension (mm) **430W 450D 200H**
Bowl 1 Dimensions (mm) **390W 410D 200H**
Cut-Out Size (mm) **Upon request**

Price :
13,850 .-
Special Price :
10,900 .-

BXX 210-36 Box

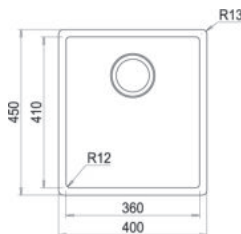

Master FUN Number
127.0434.705

Material **SS 304**
Type/Installation **Inset/Flushmount/Undermount**
Number of Bowls **1**
Exterior Dimension (mm) **400W 450D 200H**
Bowl 1 Dimensions (mm) **360W 410D 200H**
Cut-Out Size (mm) **Upon request**

Price :
12,500 .-
Special Price :
9,900 .-

BXX 210-45 Box

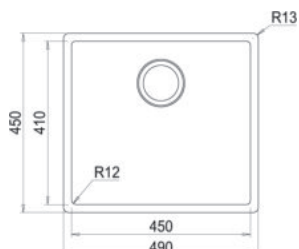

Master FUN Number
127.0432.867

Material **SS 304**
Type/Installation **Inset/Flushmount/Undermount**
Number of Bowls **1**
Exterior Dimension (mm) **490W 450D 200H**
Bowl 1 Dimensions (mm) **450W 410D 200H**
Cut-Out Size (mm) **Upon request**

Price :
14,500 .-
Special Price :
10,900 .-

BXX 210-54 Box

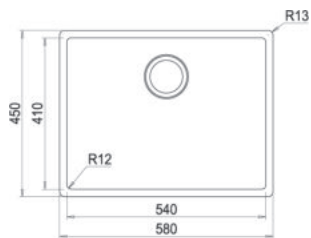

Master FUN Number
127.0433.023

Material **SS 304**
Type/Installation **Inset/Flushmount/Undermount**
Number of Bowls **1**
Exterior Dimension (mm) **580W 450D 200H**
Bowl 1 Dimensions (mm) **540W 410D 200H**
Cut-Out Size (mm) **Upon request**

Price :
16,500 .-
Special Price :
12,900 .-

BXX 210-65 Box

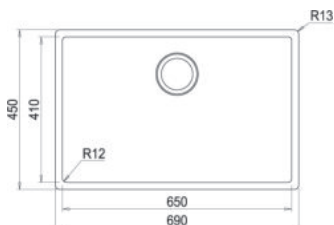

Master FUN Number
127.0433.024

Material **SS 304**
Type/Installation **Inset/Flushmount/Undermount**
Number of Bowls **1**
Exterior Dimension (mm) **690W 450D 200H**
Bowl 1 Dimensions (mm) **650W 410D 200H**
Cut-Out Size (mm) **Upon request**

Price :
20,500 .-
Special Price :
15,900 .-

BXX 210-72 Box

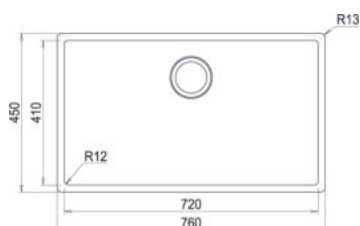

Master FUN Number
127.0433.025

Material **SS 304**
Type/Installation **Inset/Flushmount/Undermount**
Number of Bowls **1**
Exterior Dimension (mm) **760W 450D 200H**
Bowl 1 Dimensions (mm) **720W 410D 200H**
Cut-Out Size (mm) **Upon request**

Price :
22,000 .-
Special Price :
16,900 .-

Stainless Steel Sink

BXX 220-36 Box

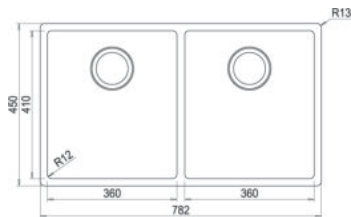

Master FUN Number
127.0434.706

Material **SS 304**
Type/Installation **Inset/Flushmount/Undermount**
Number of Bowls **2**
Exterior Dimension (mm) **782W 450D 200H**
Bowl 1 Dimensions (mm) **360W 410D 200H**
Bowl 2 Dimensions (mm) **360W 410D 200H**
Cut-Out Size (mm) **Upon request**

Price :
27,900 .-

Special Price :
20,900 .-

BXX 220-74 Box

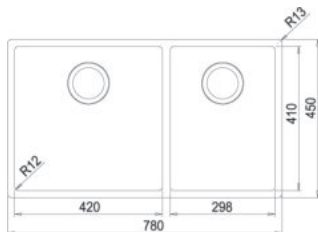

Master FUN Number
127.0433.177

Material **SS 304**
Type/Installation **Inset/Flushmount/Undermount**
Number of Bowls **2**
Exterior Dimension (mm) **780W 450D 200H**
Bowl 1 Dimensions (mm) **420W 410D 200H**
Bowl 2 Dimensions (mm) **298W 410D 200H**
Cut-Out Size (mm) **Upon request**

Price :
27,900 .-

Special Price :
20,900 .-

GAX 611* Galassia

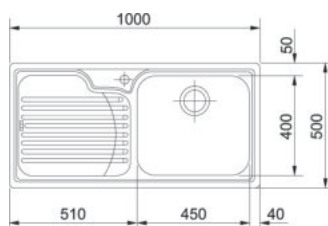

Master FUN Number
101.0022.272 /LHD
101.0022.271 /RHD

Material **SS 304**
Type/Installation **Inset**
Number of Bowls **1**
Exterior Dimension (mm) **1000W 500D 205H**
Bowl 1 Dimensions (mm) **450W 400D 205H**
Cut-Out Size (mm) **980W 480D**

Price :
11,900 .-

Special Price :
8,990 .-

RPX 621 Rapid

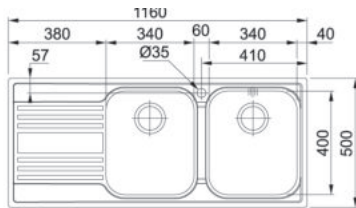

Master FUN Number

101.0358.154 /LHD
101.0358.153 /RHD

Material SS 304

Type/Installation **Inset**

Number of Bowls **2**

Exterior Dimension (mm) **1160W 500D**

Bowl 1 Dimensions (mm) **340W 400D 190H**

Bowl 1 Dimensions (mm) **340W 400D 190H**

Cut-Out Size (mm) **1140W 480D**

Price :

14,900 .-

Special Price :

11,900 .-

RPX 651* Rapid

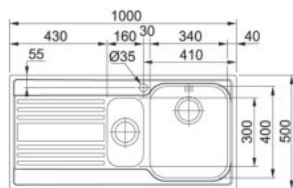

Master FUN Number

101.0358.073 /LHD
101.0358.072 /RHD

Material SS 304

Type/Installation **Inset**

Number of Bowls **2**

Exterior Dimension (mm) **1000W 500D**

Bowl 1 Dimensions (mm) **340W 400D 190H**

Bowl 2 Dimensions (mm) **160W 300D 120H**

Cut-Out Size (mm) **980W 480D**

Price :

13,900 .-

Special Price :

9,990 .-

RPX 611 Rapid

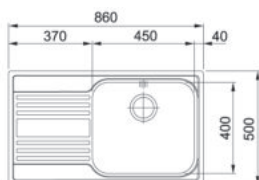

Master FUN Number

101.0358.061 /LHD
101.0358.050 /RHD

Material SS 304

Type/Installation **Inset**

Number of Bowls **1**

Exterior Dimension (mm) **860W 500D**

Bowl 1 Dimensions (mm) **450W 400D 190H**

Cut-Out Size (mm) **840W 480D**

Price :

10,000 .-

Special Price :

7,990 .-

Stainless Steel Sink

BCX 621 Bell

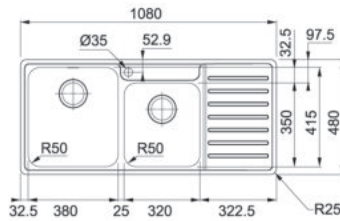

Master FUN Number

101.0547.621 /LHD
101.0438.093 /RHD

Material **SS 304**

Type/Installation **Inset**

Number of Bowls **2**

Exterior Dimension (mm) **1080W 480D**

Bowl 1 Dimensions (mm) **380W 415D 180H**

Bowl 2 Dimensions (mm) **320W 350D 160H**

Cut-Out Size (mm) **1056 W 456D**

Price :

8,100 .-

Special Price :

6,290 .-

BCX 611-86 Bell

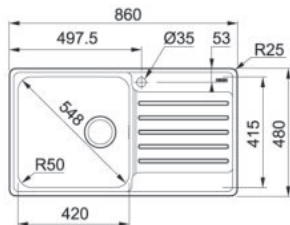

Master FUN Number

101.0438.087/RHD

Material **SS 304**

Type/Installation **Inset**

Number of Bowls **1**

Exterior Dimension (mm) **860W 480D**

Bowl 1 Dimensions (mm) **420W 415D 200H**

Cut-Out Size (mm) **836 W 456D**

Price :

5,900 .-

Special Price :

4,590 .-

BCX 620-42/35 Bell

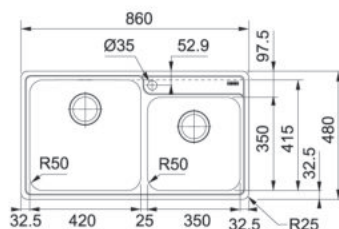

Master FUN Number

101.0438.090

Material **SS 304**

Type/Installation **Inset**

Number of Bowls **2**

Exterior Dimension (mm) **860W 480D**

Bowl 1 Dimensions (mm) **420W 415D 200H**

Bowl 2 Dimensions (mm) **350W 350D 180H**

Cut-Out Size (mm) **836 W 456D**

Price :

6,500 .-

Special Price :

5,190 .-

BCX 620-35/35 Bell

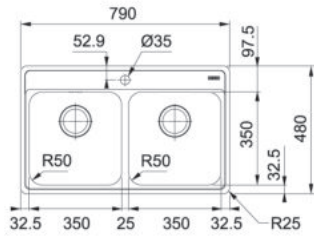

Master FUN Number
101.0438.088

Material **SS 304**
Type/Installation **Inset**
Number of Bowls **2**
Exterior Dimension (mm) **790W 480D**
Bowl 1 Dimensions (mm) **350W 350D 180H**
Bowl 2 Dimensions (mm) **350W 350D 180H**
Cut-Out Size (mm) **766W 456D**

Price :
6,500 .-
Special Price :
5,190 .-

BCX 120-35-35 Bell

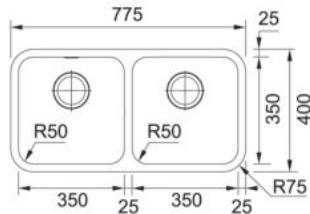

Master FUN Number
122.0438.133

Material **SS 304**
Type/Installation **Undermount**
Number of Bowls **2**
Exterior Dimension (mm) **775W 400D**
Bowl 1 Dimensions (mm) **350W 350D 180H**
Bowl 2 Dimensions (mm) **350W 350D 180H**
Cut-Out Size (mm) **Upon request**

Price :
6,900 .-
Special Price :
5,090 .-

BCX 110-75 TL Bell

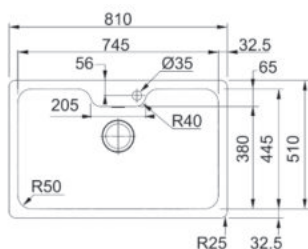

Master FUN Number
122.0438.132

Material **SS 304**
Type/Installation **Undermount**
Number of Bowls **1**
Exterior Dimension (mm) **810W 510D 200H**
Bowl 1 Dimensions (mm) **745W 445D 200H**
Cut-Out Size (mm) **Upon request**

Price :
9,500 .-
Special Price :
7,190 .-

Stainless Steel Sink

BCX 610-51 Bell

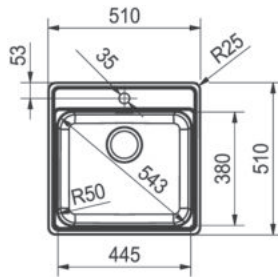

Master FUN Number
101.0549.836

Material **SS 304**
Type/Installation **Inset**
Number of Bowls **1**
Exterior Dimension (mm) **510W 510D**
Bowl 1 Dimensions (mm) **445W 380D 200H**
Cut-Out Size (mm) **500W 500D**

Price :
5,300 .-
Special Price :
3,790 .-

BCX 110-45 Bell

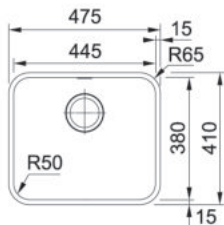

Master FUN Number
122.0438.080

Material **SS 304**
Type/Installation **Undermount**
Number of Bowls **1**
Exterior Dimension (mm) **475W 410D**
Bowl 1 Dimensions (mm) **445W 380D 200H**
Cut-Out Size (mm) **Upon request**

Price :
5,300 .-
Special Price :
3,790 .-

BCX 110-42 Bell

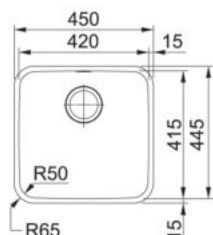

Master FUN Number
122.0438.077

Material **SS 304**
Type/Installation **Undermount**
Number of Bowls **1**
Exterior Dimension (mm) **450W 445D**
Bowl 1 Dimensions (mm) **420W 415D 200H**
Cut-Out Size (mm) **Upon request**

Price :
5,400 .-
Special Price :
3,990 .-

LNx 620-40-28* Lausanne

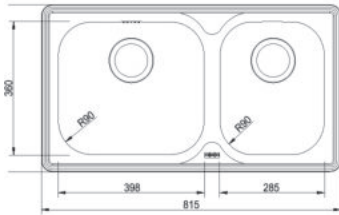

Master FUN Number
101.0625.130

Material **SS 304**
Type/Installation **Inset**
Number of Bowls **2**
Exterior Dimension (mm) **815W 450D**
Bowl 1 Dimensions (mm) **398W 360D 168H**
Bowl 2 Dimensions (mm) **285W 360D 163H**
Cut-Out Size (mm) **795W 430D**

Price :
5,500 .-
Special Price :
3,590 .-

LNx 611 Lausanne

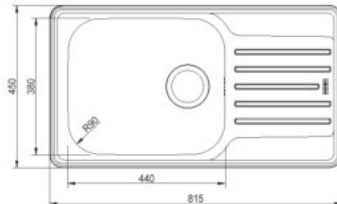

Master FUN Number
101.0625.125

Material **SS 304**
Type/Installation **Inset**
Number of Bowls **1**
Exterior Dimension (mm) **815W 450D**
Bowl 1 Dimensions (mm) **440W 380D 172H**
Cut-Out Size (mm) **795W 430D**

Price :
4,200 .-
Special Price :
2,890 .-

LNx 610-44 Lausanne

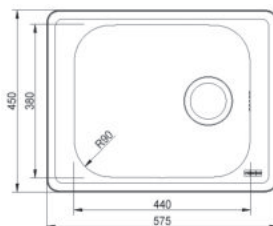

Master FUN Number
101.0625.124

Material **SS 304**
Type/Installation **Inset**
Number of Bowls **1**
Exterior Dimension (mm) **575W 450D**
Bowl 1 Dimensions (mm) **440W 380D 175H**
Cut-Out Size (mm) **555W 430D**

Price :
4,700 .-
Special Price :
2,790 .-



A cluster of fresh yellow cherry tomatoes with green stems is placed on a dark grey, textured sink. Several water droplets are scattered on the sink's surface around the tomatoes. The background shows the curved lines of the sink and a light-colored countertop.

Fragranite Sink

SPECTACULARLY BIG

A bowl that satisfies all around



Maris Fragranite Bowl

Spacious, durable, hygienic.

The new Maris Fragranite Bowl meets all the requirements for modern kitchen use. It is made from Fragranite to last a lifetime, and the material is treated with Sanitized: silver ions that prevent germs, mould and bad smells. But above all, Maris is spectacularly big. With no drainer, washing baking trays, pots and pans has never been easier.



A match with your kitchen

The Maris Fragranite bowl is the ultimate improvement to your kitchen.

Our products offer modern looks, clever functions and plenty of space – they combine design and functionality. With a Maris bowl you have a product that simply fits and creates a lot of pleasure and convenience.



A perfectly finished bowl

Our bowls are beautifully designed minimalist objects that will blend into your kitchen and simply belong. With their extremely thin rim, they are among the most striking design bowls on the market. Moreover, the bowls are offered with a drain cover and hidden overflow.



Delightfully long-lasting

The bowl includes quartz, one of the hardest materials known to man, and is resistant to temperatures up to 180° C. It's also resilient to impact and thermal shock, and so scratch-resistant that even knives won't leave marks on the surface.



Amazingly hygienic

What would a bowl be if it wasn't easy to clean? Our bowls are simple to wash and particularly hygienic because they are enhanced with Sanitized, a material that contains silver ions that reduce the growth of bacteria and microbes by 99%.



FSG 611-88 Fresno

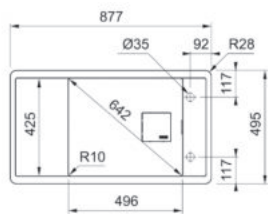

Master FUN Number
114.0612.500 / Oyster *
114.0612.495 / Onyx

Material **Granite**
Type/Installation **Inset**
Number of Bowls **1**
Exterior Dimension (mm) **877W 495D**
Bowl 1 Dimensions (mm) **496W 425D 195H**
Cut-Out Size (mm) **845W 463D**
Pop-up

Color  **Oyster**  **Onyx**

Included Accessories

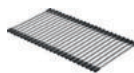

Rolling Mat
112.0520.938
220 x 400 (mm.)

Price :
65,500 .-
Special Price :
53,390 .-

KNG 120 Kubus 2

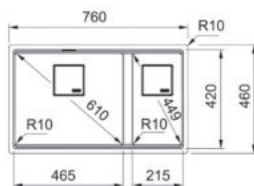

Master FUN Number
125.0529.871 / Onyx

Material **Granite**
Type/Installation **Undermount**
Number of Bowls **2**
Exterior Dimension (mm) **760W 460D**
Bowl 1 Dimensions (mm) **465W 420D 200H**
Bowl 2 Dimensions (mm) **215W 420D 200H**
Cut-Out Size (mm) **Upon Request**
Pop-up

Color  **Onyx**

Included Accessories



Rolling Mat
112.0256.867
410 x 298 (mm.)



Strainer Bowl
112.0394.981
156 x 429 x 54 (mm.)



Wooden Chopping Board
112.0654.748
230 x 442 x 20 (mm.)

Price :
55,900 .-
Special Price :
43,900 .-

KNG 110-62 Kubus 2

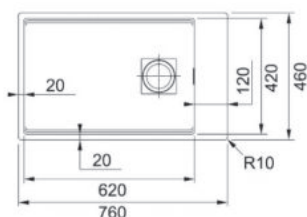

Master FUN Number
125.0529.612 / Onyx

Material **Granite**
Type/Installation **Undermount**
Number of Bowls **1**
Exterior Dimension (mm) **760W 460D**
Bowl 1 Dimensions (mm) **620W 420D 200H**
Cut-Out Size (mm) **Upon Request**
Pop-up

Color  **Onyx**

Included Accessories



Rolling Mat
112.0256.867
410 x 298 (mm.)



Strainer Bowl
112.0394.981
156 x 429 x 54 (mm.)



Wooden Chopping Board
112.0654.748
230 x 442 x 20 (mm.)

Price :
52,500 .-
Special Price :
42,790 .-

Fragranite Sink

MTF 651* Mythos Fusion

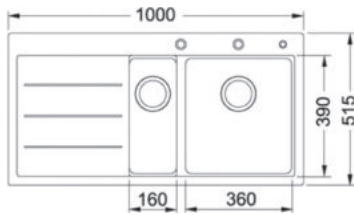

Master FUN Number

114.0156.981 /LHD
114.0156.992 /RHD

Material Granite

Type/Installation **Inset**

Number of Bowls **2**

Exterior Dimension (mm) **1000W 515D 214H**

Bowl 1 Dimensions (mm) **360W 390D 200H**

Bowl 2 Dimensions (mm) **160W 390D 153H**

Cut-Out Size (mm) **980W 495D**

Pop-up

Color  **Onyx**

Included Accessories



Glass Chopping Board

112.0017.900
408 x 280 x 10 (mm.)



Strainer Bowl

112.0018.817
160 x 405 x 55 (mm.)

Price :

41,900 .-

Special Price :

31,900 .-

MTF 611* Mythos Fusion

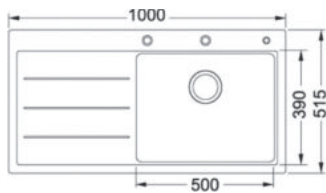

Master FUN Number

114.0157.287 /RHD

Material Granite

Type/Installation **Inset**

Number of Bowls **1**

Exterior Dimension (mm) **1000W 515D 214H**

Bowl 1 Dimensions (mm) **500W 390D 190H**

Cut-Out Size (mm) **980W 495D**

Pop-up

Color  **Onyx**

Included Accessories



Glass Chopping Board

112.0017.900
408 x 280 x 10 (mm.)



Strainer Bowl

112.0018.817
160 x 405 x 55 (mm.)

Price :

40,900 .-

Special Price :

30,900 .-

MRG 621 Maris

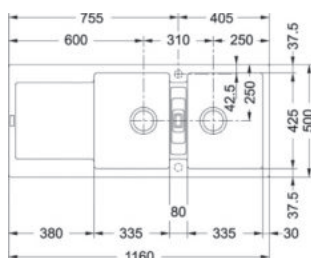
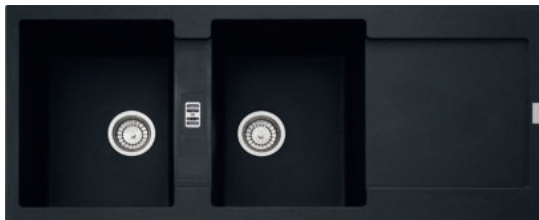

Master FUN Number

114.0152.498 /Onyx
114.0153.948 /White

Material Granite

Type/Installation **Inset**

Number of Bowls **2**

Exterior Dimension (mm) **1160W 500D 200H**

Bowl 1 Dimensions (mm) **335W 425D 200H**

Bowl 2 Dimensions (mm) **335W 425D 200H**

Cut-Out Size (mm) **1140W 480D**

Color  **Onyx**  **Polar White**

Price :

25,900 .-

Special Price :

19,900 .-

MRG 620 Maris

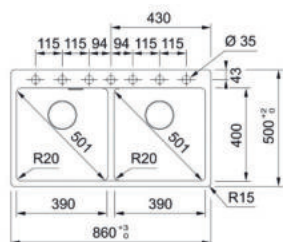

Master FUN Number

114.0666.363 / Onyx
144.0666.366 / White

Material Granite

Type/Installation **Inset**

Number of Bowls **2**

Exterior Dimension (mm) **860W 500D 200H**

Bowl 1 Dimensions (mm) **390W 400D 200H**

Bowl 2 Dimensions (mm) **390W 400D 200H**

Cut-Out Size (mm) **840W 480D**

Color  **Onyx**  **Polar White**

Price :
28,000 .-
Special Price :
21,000 .-

MRG 651 Maris

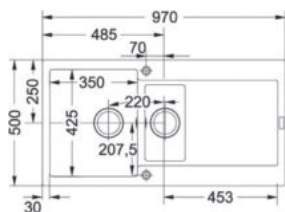

Master FUN Number

114.0157.500 / Onyx
114.0153.911 / White

Material Granite

Type/Installation **Inset**

Number of Bowls **2**

Exterior Dimension (mm) **970W 500D 200H**

Bowl 1 Dimensions (mm) **350W 425D 200H**

Bowl 2 Dimensions (mm) **160W 302D 120H**

Cut-Out Size (mm) **950W 480D**

Color  **Onyx**  **Polar White**

Price :
22,900 .-
Special Price :
17,900 .-

MRG 611 L Maris

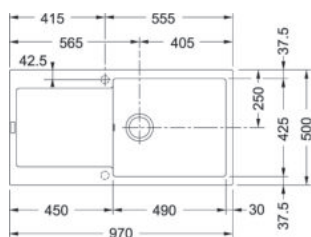
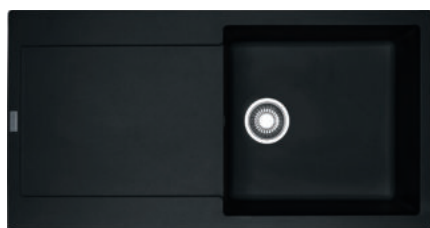

Master FUN Number

114.0152.495 / Onyx
114.0153.910 / White

Material Granite

Type/Installation **Inset**

Number of Bowls **1**

Exterior Dimension (mm) **970W 500D 200H**

Bowl 1 Dimensions (mm) **490W 425D 200H**

Cut-Out Size (mm) **950W 480D**

Color  **Onyx**  **Polar White**

Price :
22,900 .-
Special Price :
17,900 .-

Fragranite Sink

MRG 110-72 Maris

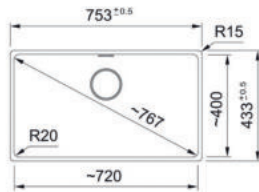

Master Fun Number
135.0665.726 / Onyx

Material **Granite**
Type/Installation **Undermount**
Number of Bowls **1**
Exterior Dimension (mm) **753W 433D 200H**
Bowl 1 Dimensions (mm) **720W 400D 200H**
Cut-Out Size (mm) **Upon Request**

Color  **Onyx**

Price :
34,900 .-
Special Price :
25,900 .-

MRG 110-52 Maris

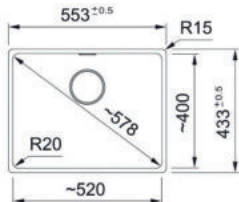

Master FUN Number
135.0665.786 / Onyx
135.0665.789 / White

Material **Granite**
Type/Installation **Undermount**
Number of Bowls **1**
Exterior Dimension (mm) **553W 433D 200H**
Bowl 1 Dimensions (mm) **520W 400D 200H**
Cut-Out Size (mm) **Upon Request**

Color  **Onyx**  **Polar White**

Price :
28,500 .-
Special Price :
21,500 .-

CNG 611-100* Onyx

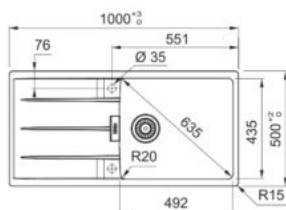

Master FUN Number
114.0621.065 / Onyx

Material **Granite**
Type/Installation **Inset/Flushmount**
Number of Bowls **1**
Exterior Dimension (mm) **1000W 500D 200H**
Bowl 1 Dimensions (mm) **492W 435D 200H**
Cut-Out Size (mm) **970W 470D**

Color  **Onyx**

Price :
19,000 .-
Special Price :
14,900 .-

CNG 610-73* Onyx

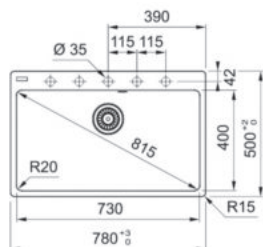
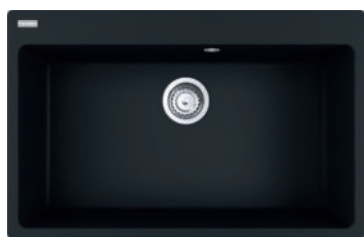

Master FUN Number

114.0620.954 /Onyx

Material Granite

Type/Installation **Inset/Flushmount**

Number of Bowls **1**

Exterior Dimension (mm) **780W 500D 200H**

Bowl 1 Dimensions (mm) **723W 425D 230H**

Cut-Out Size (mm) **760W 480D**

Color  **Onyx**

Price :
16,500 .-

Special Price :
12,900 .-

UBG 621-116 Onyx

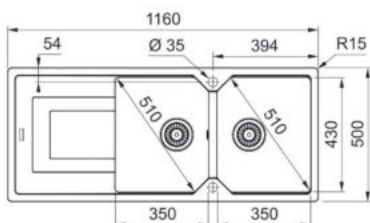

Master FUN Number

114.0551.380

Material Granite

Type/Installation **Inset**

Number of Bowls **2**

Exterior Dimension (mm) **1160W 500D**

Bowl 1 Dimensions (mm) **350W 430D 220H**

Bowl 2 Dimensions (mm) **350W 430D 220H**

Cut-Out Size (mm) **1124W 464D**

Color  **Onyx**

Included Accessories



**WK SET FOR SINK
UBG 2 VIA**

112.0564.576
440 x 181 x 92 (mm.)

Price :
22,000 .-

Special Price :
16,900 .-

UBG 620-86

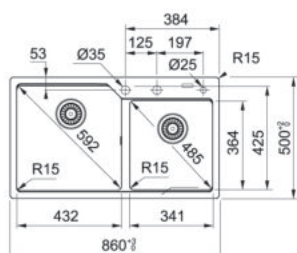
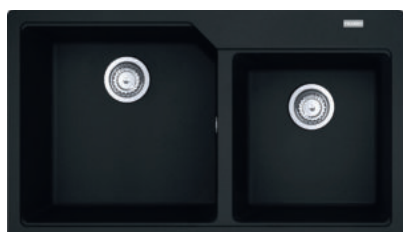

Master FUN Number

114.0558.014

Material Granite

Type/Installation **Inset**

Number of Bowls **2**

Exterior Dimension (mm) **860W 500D**

Bowl 1 Dimensions (mm) **432W 425D 230H**

Bowl 2 Dimensions (mm) **341W 364D 220H**

Cut-Out Size (mm) **824W 464D**

Color  **Onyx**

Included Accessories



**WK SET FOR SINK
UBG 620**

112.0577.591
440 x 181 x 92 (mm.)

Price :
19,000 .-

Special Price :
14,900 .-

Fragranite Sink

UBG 611-100 Onyx

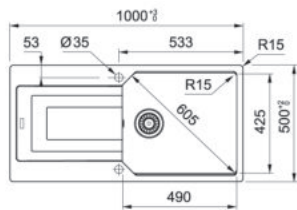

Master FUN Number
114.0548.507

Material Granite
Type/Installation Inset
Number of Bowls 1
Exterior Dimension (mm) 1000W 500D
Bowl 1 Dimensions (mm) 490W 425D 220H
Cut-Out Size (mm) 980W 480D

Color  **Onyx**

Included Accessories



WK SET FOR SINK
UBG 1 VIA
112.0547.886
440 x 181 x 92 (mm.)

Price :
19,000 .-
Special Price :
14,900 .-

UBG 610-78 Onyx

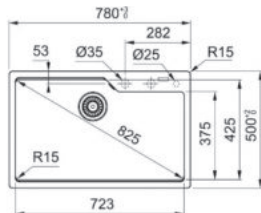

Master FUN Number
114.0551.321

Material Granite
Type/Installation Inset
Number of Bowls 1
Exterior Dimension (mm) 780W 500D
Bowl 1 Dimensions (mm) 723W 425D 230H
Cut-Out Size (mm) 755W 480D

Color  **Onyx**

Included Accessories



WK SET FOR SINK
UBG 1 VIA
112.0547.886
440 x 181 x 92 (mm.)

Price :
16,500 .-
Special Price :
12,900 .-

UBG 610-56 Urban

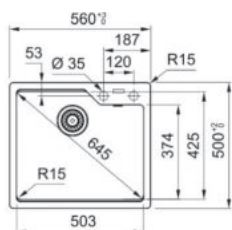

Master FUN Number
114.0551.402 / Onyx

Material Granite
Type/Installation Inset
Number of Bowls 1
Exterior Dimension (mm) 560W 500D
Bowl 1 Dimensions (mm) 503W 425D 230H
Cut-Out Size (mm) 524W 464D

Color  **Onyx**

Included Accessories



WK SET FOR SINK
UBG 1 VIA
112.0577.497
440 x 181 x 92 (mm.)

Price :
14,900 .-
Special Price :
11,900 .-





FRANKE



Tap



PESCARA



With a sleek, modern design, Pescara adds professional flair and maximum function to the home kitchen. It features a single-lever handle and pull-down sprayer that fits comfortably in your hand for effortless operation. Intuitive, ergonomic design allows easy toggling between spray and stream.



Dual function spray head

Easily toggle between spray and stream without the need to reduce water pressure between modes.

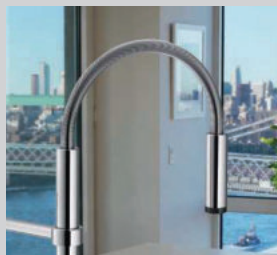

Durable coil spring hose

The coil spring hose provides great flexibility for complete reach of the entire sink.

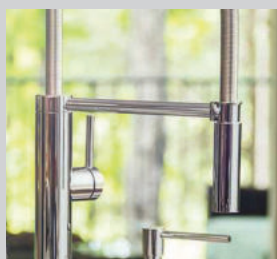

Magnetic docking

An intuitive, quick release, magnetic dock holds the spray head securely in place when not in use.



Full Coverage Swivel

The 360 degree swivel spout generates a full range of motion, allowing you the flexibility to reach almost any area of your sink. The tall arch design offers exceptional space for cleaning or filling large pots and pans.



PESCARA 360



Master FUN Number
115.0393.976

Material **Brass**
Surface Finish **Chrome**
Spout Type **Pull out spray**
Swivel Spout Rotation Angle **360**

Price :
43,900 .-

Special Price :
33,900 .-

PESCARA XL

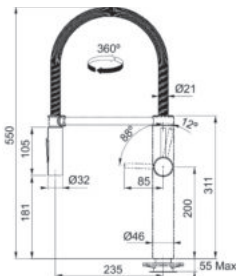

Master FUN Number
115.0393.974

Material **Brass**
Surface Finish **Chrome**
Spout Type **Pull down spray**
Swivel Spout Rotation Angle **360**

Price :
38,900 .-

Special Price :
29,900 .-

Lounge

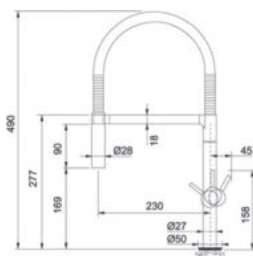

Master FUN Number
115.0177.640

Material **Brass**
Surface Finish **Chrome**
Spout Type **Pull out spray**
Swivel Spout Rotation Angle **360**

Price :
34,900 .-

Special Price :
25,900 .-

Tap

ACTIVE PLUS PULL OUT

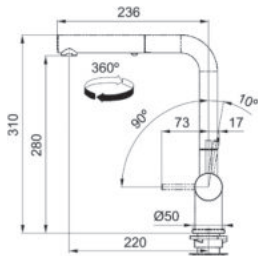

Master FUN Number
115.0524.890 / Black Matt

Material **Brass**
Surface Finish **Black Matt**
Spout Type **Pull out spray**
Swivel Spout Rotation Angle **360**

Price :
28,900 .-
Special Price :
19,990 .-

ACTIVE PLUS PULL OUT

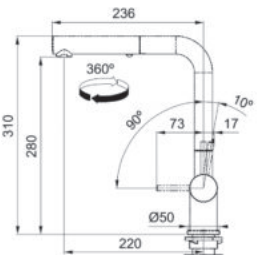

Master FUN Number
115.0373.770

Material **Brass**
Surface Finish **Chrome**
Spout Type **Pull out nozzle**
Swivel Spout Rotation Angle **360**

Price :
20,500 .-
Special Price :
15,900 .-

ACTIVE PLUS SWIVEL *

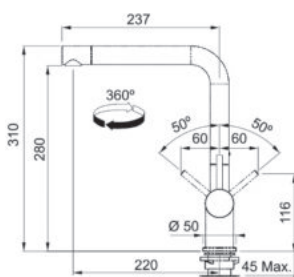

Master FUN Number
115.0373.790

Material **Brass**
Surface Finish **Chrome**
Spout Type **Swivel spout**
Swivel Spout Rotation Angle **360**

Price :
15,800 .-
Special Price :
11,990 .-

Maris Pull Out



Master FUN Number
115.0392.382 / ONYX
115.0392.368 / POLAR WHITE*

Material **Brass**
Surface Finish **Chrome & ONYX / POLAR WHITE**
Spout Type **Pull out spray**
Swivel Spout Rotation Angle **360**

Price :
27,900 .-
Special Price :
20,900 .-

Maris Swivel



Master FUN Number
115.0392.356 / ONYX
115.0392.340 / POLAR WHITE*

Material **Brass**
Surface Finish **Chrome & ONYX / POLAR WHITE**
Spout Type **Swivel spout**
Swivel Spout Rotation Angle **360**

Price :
22,900 .-
Special Price :
17,900 .-

Neptune Evo Pull Out

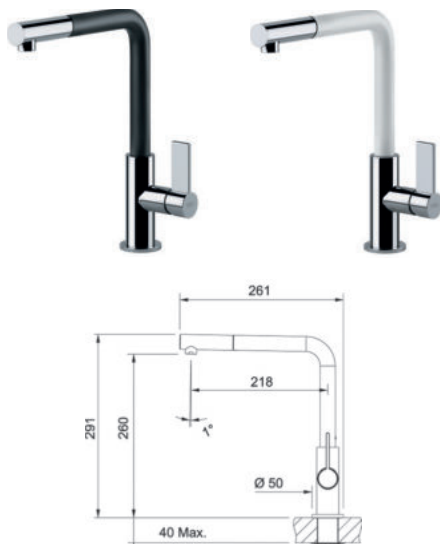

Master FUN Number
115.0373.945 / Black
115.0373.944 / White

Material **Brass**
Surface Finish **Chrome**
Spout Type **Pull out nozzle**
Swivel Spout Rotation Angle **360**

Price :
20,500 .-
Special Price :
15,900 .-

Tap

Joy Cocktail



Master FUN Number
115.0029.591

Material **Brass**
Surface Finish **Chrome**
Spout Type **Pull down spray**
Swivel Spout Rotation Angle **360**

Price :
17,900 .-
Special Price :
13,900 .-

Novara Eco

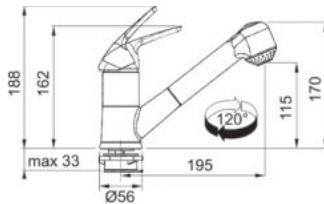

Master FUN Number
115.0380.642

Material **Brass**
Surface Finish **Chrome**
Spout Type **Pull out spray**
Swivel Spout Rotation Angle **120**

Price :
17,900 .-
Special Price :
13,900 .-

Smart Pro

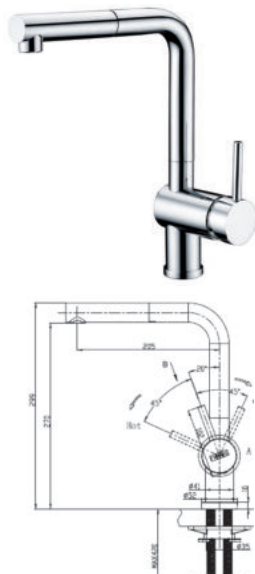

Master FUN Number
115.0598.239

Material **Brass**
Surface Finish **Chrome**
Spout Type **Pull out nozzle**
Swivel Spout Rotation Angle **360**

Price :
10,900 .-
Special Price :
8,390 .-

Smart

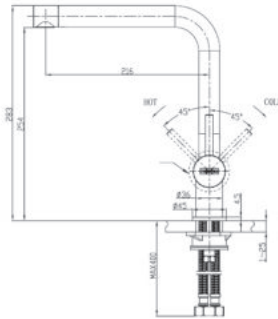

Master FUN Number
115.0598.238

Material **Brass**
Surface Finish **Chrome**
Spout Type **Swivel spout**
Swivel Spout Rotation Angle **360**

Price :
5,200 .-
Special Price :
3,990 .-

Curve

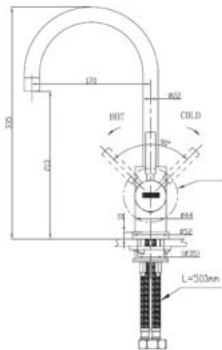

Master FUN Number
115.0598.237

Material **Brass**
Surface Finish **Chrome**
Spout Type **Swivel spout**
Swivel Spout Rotation Angle **360**

Price :
4,100 .-
Special Price :
3,100 .-

OBX*

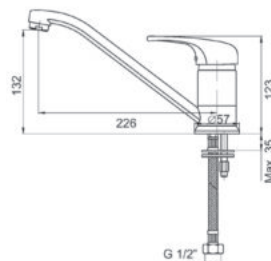

Master FUN Number
115.0044.818

Material **Brass**
Surface Finish **Chrome**
Spout Type **Swivel spout**
Swivel Spout Rotation Angle **360**

Price :
3,200 .-
Special Price :
1,990 .-





Hob

Induction Hob

72 - 74

Ceramic Hob

75 - 75

Gas Hob

76 - 79

MYTHOS INDUCTION HOB

When cooking becomes art



Delight yourself and your guests with a kitchen that looks timeless and stylish. Enjoy perfectly balanced design features set against dark glass surfaces. The Mythos range of appliances will also amaze you with their performance and quality. The look and the effectiveness of Mythos makes it an acclaimed classic.

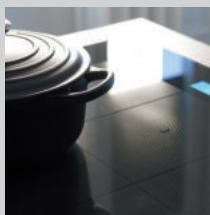

Design and Installation

Superb result from the High Tech Design 3D effect, without frame, which allows it to be installed semi-flush or flush with the top.

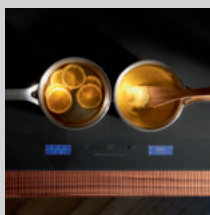

Touch control display

The double LCD touch control display, together with the slider central, they help to manage the eight zones with a few touches a induction to have everything under control with great ease.



CookAssist

With CookAssist function, cooking with Mythos is a breeze. With the right setting on your hob, you can cook a steak to perfection and not worry about burning it. There is a range of functions, such as the fantastic slow cooking function. You can use this one to get your meat and fish perfectly tender and succulent, exactly the way you want it.



Flexible cooking

The large induction hob will astonish you with up to eight cooking zones. Big pots, small pans, whatever you want to heat up – with the FlexPro zone feature on your new hob, you can do it all at the same time. That's comfortable cooking.



FMY 839 HI Mythos 2-gether

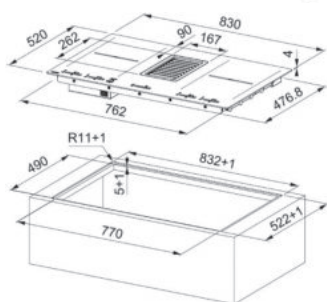

Master FUN Number
340.0597.249

Feature & Benefits for Hob
Material **Ceramic Glass**
Number of Heating Zone **4**
Max Output **7.4 kW**
Exterior Dimension (mm) **830W 520D**
Cavity Dimension (mm) **Upon request**

Eurokera Tempered Ceramic Glass
4 x 220x180mm 2.1kW Booster 3.7kW (Flexi Zone 3.7kW)
9 Power Stage Settings
Keep Warm Function
Pan Sensor
Child Lock
Safety Switch
Burner/Heating Zones 4
Automatic Cut Off Timer
Sliding Touch Controls
Residual Heat Indicator
Overheating Protection
4 Timer - Simultaneous Usable

Feature & Benefits for Hood
Energy Efficiency class A+++
Filter Saturation Indicator
Automatic Activation
8 Speed + Intensive

Material **Tempered Glass**
Max Air Flow **1200 m³/h**
Max Noise Level **65db(A)**
Kit Recirculation 112.0539.570
Replacement Charcoal Filter 112.0548.448
Kit Exhaust Hob Extractor 112.0539.569 (Optional)
CURVE CRC 90 220X90 112.0459.451 (Optional)

Price :
195,000 .-

Special Price :
159,000 .-

FMY 808 I FP BK Mythos

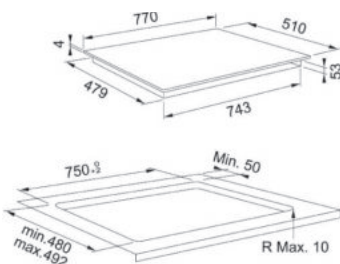
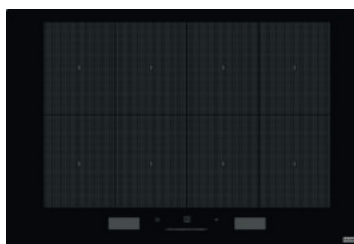

Master FUN Number
108.0613.588

Feature & Benefits
1200W - Booster 1800W All Zone
18 Power Stage Settings
Keep Warm Function
Pan Sensor
Child Lock
Safety Switch
Automatic Cut Off Timer
LCD Display with Sliding Touch Control
Residual Heat Indicator
Overheating Protection

Material **Ceramic Glass**
Number of Heating Zone **8 - Flexi Full**
Max Output **7.4 kW**
Power management (kW) **2.5 kW- 4.0 kW - 6.0 kW - 7.4 kW**
Exterior Dimension (mm) **770W 510D (R5mm)**
Cut-Out (mm) **750W 480D**

Price :
135,000 .-

Special Price :
106,900 .-

FMA 804 I F BK Maris

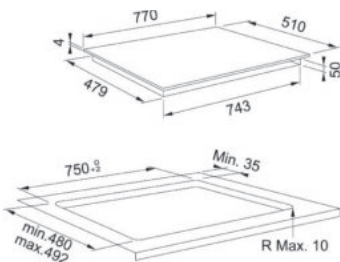
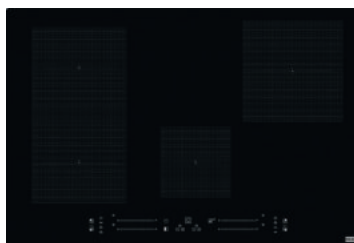

Master FUN Number
108.0606.112

Feature & Benefits
Schott Tempered Ceramic Glass
2-X-200X170-MM-1750W,- BOOSTER-2200W-
Ø-210MM-2100W,-BOOSTER-3000W
Ø-145MM-1200W,-BOOSTER-1600W
18 Power Stage Settings
Keep Warm Function
Pan Sensor
Child Lock
Safety Switch
Automatic Cut Off Timer
Sliding Touch Control
Residual Heat Indicator
Overheating Protection

Material **Ceramic Glass**
Number of Heating Zone **4 (2 Flexi)**
Max Output **7.2 kW**
Power management (kW) **2.5 kW- 4.0 kW - 6.0 kW - 7.2 kW**
Exterior Dimension (mm) **770W 510D (R5mm)**
Cut-Out (mm) **750W 480D**

Price :
84,500 .-

Special Price :
69,500 .-

Induction Hob

FSM 654 I BK Smart

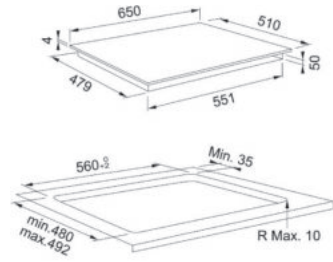

Master FUN Number
108.0606.107

Feature & Benefits
Schott Tempered Ceramic Glass
2 x Ø 145mm-1200W Booster 1600W
1 x Ø 210mm-2100W Booster 3000W
1 x Ø 180mm-1800W Booster 2100W
9 Power Stage Settings
Keep Warm Function
Pan Sensor
Child Lock
Safety Switch
Automatic Cut Off Timer
Touch Control
Residual Heat Indicator
Overheating Protection

Material **Ceramic Glass**
Number of Heating Zone **4**
Max Output **7.2 kW**
Power management (kW) **2.5 kW- 4.0 kW - 6.0 kW - 7.2 kW**
Exterior Dimension (mm) **650W 510D (R5mm)**
Cut-Out (mm) **560W 480D**

Price :
59,900 .-
Special Price :
49,900 .-

FIH6310 Onyx

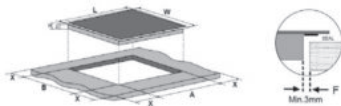
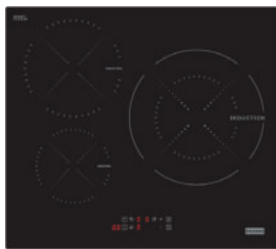

L(mm)	W(mm)	H(mm)	D(mm)	A(mm)	B(mm)	X(mm)
590	520	60	56	560 ⁺¹	490 ⁺¹	50 mini

Master FUN Number
108.0636.342

Feature & Benefits
Schott Tempered Ceramic Glass
Ø-290MM Dual zone-3000W Booster 3600W
Ø-210MM-2300W Booster 2600W
Ø-160MM-1300W Booster 1500W
9 Power Stage Settings
Electronic timer (99 Min)
Safety cooling device
Overheat protection
Child lock
Residual heat indicator

Material **Ceramic Glass**
Number of Heating Zone **3**
Max Output **7.2 kW**
Exterior Dimension (mm) **590W 520D**
Cut-Out (mm) **565W 495D**

Price :
47,900 .-
Special Price :
37,900 .-

FIH3210 Onyx

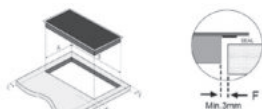

A(mm)	B(mm)	C(mm)	D(mm)	E(mm)	F(mm)	G
288 ⁺¹	520 ⁺¹	60mm	56 mm	56 mm	50 min.	50 min.

Master FUN Number
108.0635.101

Feature & Benefits
Schott Tempered Ceramic Glass
Ø-180MM-1500W Booster 2000W
Ø-140MM-1200W Booster 1500W
9 Power Stage Settings
Electronic timer (99 Min)
Safety cooling device
Overheat protection
Child lock
Residual heat indicator

Material **Ceramic Glass**
Number of Heating Zone **2**
Max Output **3.6 kW**
Exterior Dimension (mm) **288W 520D**
Cut-Out (mm) **268W 500D**

Price :
29,900 .-
Special Price :
22,990 .-

FHT571 603C T

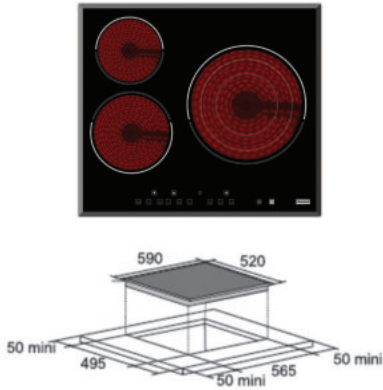

Master FUN Number
108.0258.438

Features & Benefits
Eurokera Tempered Ceramic Glass
Front Left Burner 1.8KW
Rear Left Burner 1.2KW
Front Right Burner 2.7KW
Residual Heat Indicator
Auto Switch Off Safety
Touch Control
Timer Function

Material **Tempered Ceramic Glass**
MAX Output **5.7KW**
Exterior Dimensions (mm) **590W 520D 50H**
Cut-Out (mm) **565W 495D**

Price :
25,900 .-

Special Price :
19,900 .-

FHF605 604C T

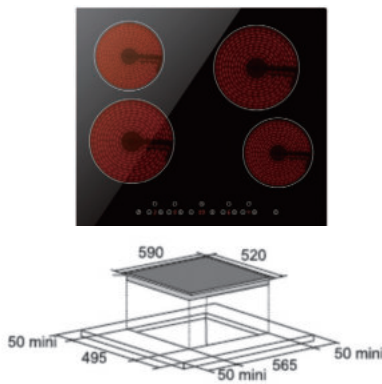

Master FUN Number
108.0183.706

Features & Benefits
Schott Tempered Ceramic Glass
Front Left Burner 1.8KW
Rear Left Burner 1.2KW
Front Right Burner 1.2KW
Rear Right Burner 1.8KW
Residual Heat Indicator
Touch Control
Timer Function

Material **Tempered Ceramic Glass**
MAX Output **6.0KW**
Exterior Dimensions (mm) **590W 520D 50H**
Cut-Out (mm) **565W 495D**

Price :
24,900 .-

Special Price :
18,900 .-

FHD301 302C T

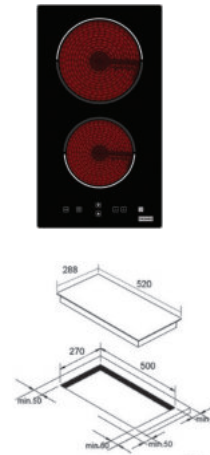

Master FUN Number
108.0291.809

Material **Tempered Ceramic Glass**
MAX Output **3.0kW**
Exterior Dimensions (mm) **288W 520D 55H**
Cavity Dimension (mm) **270W 500D**

Features & Benefits
Schott Tempered Ceramic Glass
Front Burner 1.2kW
Rear Burner 1.8kW
Residual Heat Indicator
Touch Control
Timer Function

Price :
14,900 .-

Special Price :
11,500 .-

FHR 704 C TOD BK*

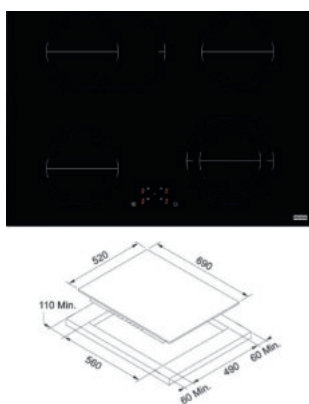

Master FUN Number
108.0530.028

Feature & Benefits for Hob
High Quality Tempered Ceramic Glass
Front left ø 140mm 1.2kW
Rear left Oval ø140/250mm 1.0kW/1.8kW
Rear right ø 140mm 1.2kW
Front right Dual ø 122/180mm, 0.7kW/1.7kW
9 Power Stage Settings
Pan Sensor
Child Lock
Burner/Heating Zones 4
Touch Controls
Residual Heat Indicator

Material **Ceramic Glass**
Number of Heating Zone **4**
Max Output **6 KW**
Exterior Dimension (mm) **690W 520D 64H**
Cavity Dimension (mm) **560W 490D**

Price :
34,000 .-

Special Price :
27,900 .-

FHR 302 C TD BK*



Master FUN Number
108.0530.009

Feature & Benefits for Hob
High Quality Tempered Ceramic Glass
Front ø 140mm 1.2kW
Rear Dual ø120/180mm 0.7kW/1.7kW
9 Power Stage Settings
Pan Sensor
Child Lock
Burner/Heating Zones 2
Touch Controls
Residual Heat Indicator

Material **Ceramic Glass**
Number of Heating Zone **2**
Max Output **2.9 KW**
Exterior Dimension (mm) **300W 520D 62H**
Cavity Dimension (mm) **270W 490D**

Price :
14,900 .-

Special Price :
10,900 .-



FHCR 905 4G TC HE BK C* Crystal



Master FUN Number
106.0374.288

Features & Benefits
High Quality Tempered Glass
Auxiliary 1.0kW
Semirapid 2x1.75kW
Rapid 3.0kW
Triple Crown 4.0kW
Safety Valve
Cast Iron Pan Support
Incorporated Electronic Ignition

Material **Tempered Glass**
MAX Output **11.5kW**
Exterior Dimensions (mm) **880W 510D**
Cut-out (mm) **840W 480D**

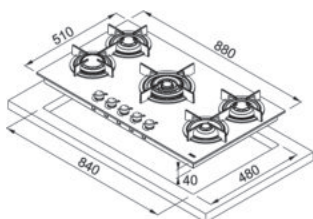

Price :
55,900 .-
Special Price :
45,900 .-

FHCR 755 4G TC HE BK C Crystal



Master FUN Number
106.0374.283

Features & Benefits
High Quality Tempered Glass
Auxiliary 1.0kW
Semi-Rapid 2x2.0kW
Semi-Rapid 1.75kW
Triple Crown 4.0kW
Safety Valve
Cast Iron Pan Support
Incorporated Electronic Ignition

Material **Tempered Glass**
MAX Output **10.75kW**
Exterior Dimensions (mm) **750W 510D**
Cut-out (mm) **560W 480D**

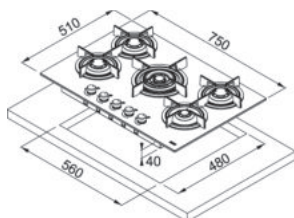

Price :
53,900 .-
Special Price :
43,900 .-

FHX 604 3G 1C BK C*



Master FUN Number
107.0152.816

Features & Benefits
High Quality Tempered Glass
1 Gas burner 3.0kW
1 Gas burner 1.75kW
1 Gas burner 1.0kW
1 Electric burner 1.2kW
Cast Iron Pan Support

Material **Tempered Glass**
MAX Output **1.2kW(E), 5.75kW(G)**
Exterior Dimensions (mm) **590W 510D**
Cut-out (mm) **560W 480D**

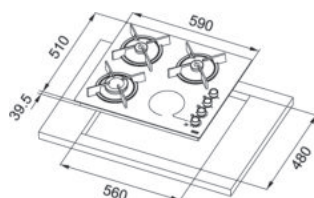

Price :
42,900 .-
Special Price :
32,900 .-

Gas Hob

FG 8228 Onyx



Master FUN Number
106.0534.896

Feature & Benefits
High Quality Tempered Glass
Left Burner 5.5kW
Right Burner 5.5kW
Flame Failure Device Equipped
Cast Iron Pan Support
LED white lighting power display
Electrical timer with LED display: 0-180 min

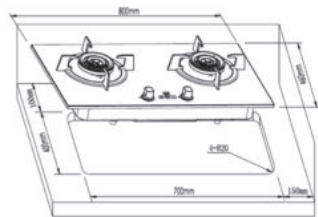

Material **Stainless Steel**
Max Output **11 KW**
Exterior Dimension (mm) **800W 460D 150H**
Cavity Dimension (mm) **700W 400D**

Price :
22,900 .-
Special Price :
17,900 .-

FG 7226 Onyx



Master FUN Number
106.0534.806

Feature & Benefits
High Quality Tempered Glass
Left Burner 5.0kW
Right Burner 5.0kW
Flame Failure Device Equipped
Cast Iron Pan Support
LED white lighting power display
Electrical timer with LED display: 0-180 min

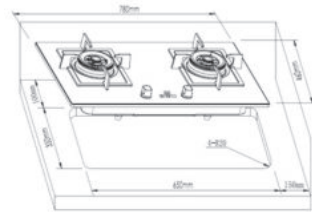

Material **Stainless Steel**
Max Output **10 KW**
Exterior Dimension (mm) **780W 460D 150H**
Cavity Dimension (mm) **650W 350D**

Price :
19,000 .-
Special Price :
14,590 .-

JZT FG 6416 Onyx

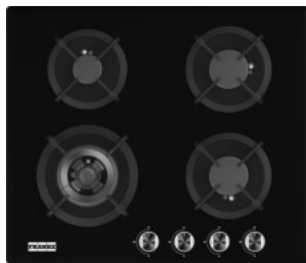

Master FUN Number
106.0534.907

Features & Benefits
High Quality Tempered Glass
Front Left Burner 1.4kW
Rear Left Burner 4.2kW
Front Right Burner 2.0kW
Rear Right Burner 2.0kW
Flame Failure Device Equipped
Cast Iron Pan Support

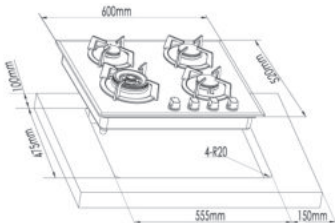

Material **Tempered Glass**
Max Output **9.6 KW**
Exterior Dimension (mm) **600W 520D 150H**
Cavity Dimension (mm) **555W 475D**

Price :
17,000 .-
Special Price :
13,500 .-

JZT FS 6416 Onyx



Master FUN Number
106.0534.909

Features & Benefits
Front Left Burner 1.4kW
Rear Left Burner 4.2kW
Front Right Burner 2.0kW
Rear Right Burner 2.0kW
Flame Failure Device Equipped
Cast Iron Pan Support

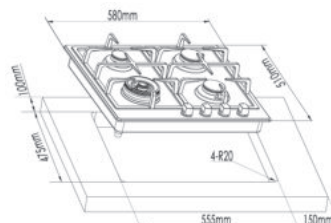

Material **Stainless Steel**
Max Output **9.6 KW**
Exterior Dimension (mm) **580W 510D 150H**
Cavity Dimension (mm) **555W 475D**

Price :
14,900 .-
Special Price :
11,900 .-

FHG 8318 Onyx

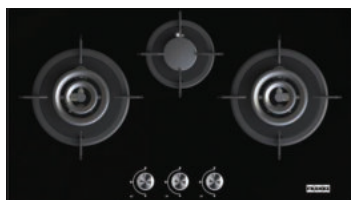

Master FUN Number
106.0534.663

Features & Benefits
High Quality Tempered Glass
Front Left Burner 5.5kW
Rear Middle Burner 1.8kW
Front Right Burner 5.5kW
Flame Failure Device Equipped

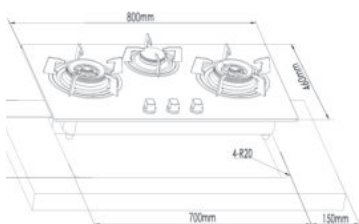

Material **Tempered Glass**
Max Output **12.8 KW**
Exterior Dimension (mm) **800W 460D 150H**
Cavity Dimension (mm) **700W 400D**

Price :
17,900 .-
Special Price :
13,900 .-

FHG 8312 Onyx



Master FUN Number
106.0534.674

Features & Benefits
High Quality Tempered Glass
Front Left Burner 4.5kW
Rear Middle Burner 1.4kW
Front Right Burner 4.5kW
Flame Failure Device Equipped

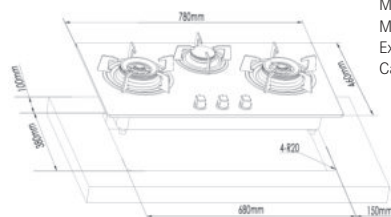

Material **Tempered Glass**
Max Output **10.4 KW**
Exterior Dimension (mm) **780W 460D 150H**
Cavity Dimension (mm) **680W 380D**

Price :
13,900 .-
Special Price :
9,500 .-

FHG 7212 Onyx



Master FUN Number
106.0530.870

Feature & Benefits
High Quality Tempered Glass
Left Burner 4.5kW
Right Burner 4.5kW
Flame Failure Device Equipped
Cast Iron Pan Support

Material **Stainless Steel**
Max Output **9 KW**
Exterior Dimension (mm) **730W 420D 150H**
Cavity Dimension (mm) **630W 330D**

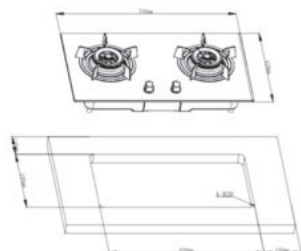

Price :
11,900 .-
Special Price :
7,890 .-

FGH 3116 Onyx



Master FUN Number
106.0534.911

Features & Benefits
High Quality Tempered Glass
Front Burner 4.2kW
Flame Failure Device Equipped

Material **Tempered Glass**
Max Output **4.2 KW**
Exterior Dimension (mm) **310W 520D 132H**
Cavity Dimension (mm) **265W 490D**

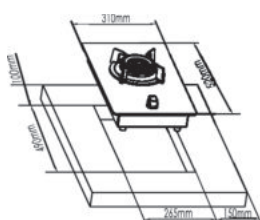

Price :
10,500 .-
Special Price :
7,890 .-

FGH 3216 Onyx



Master FUN Number
106.0534.913

Features & Benefits
High Quality Tempered Glass
Rear Burner 2.2kW
Front Burner 1.4kW
Flame Failure Device Equipped

Material **Tempered Glass**
MAX Output **3.6kW**
Exterior Dimensions (mm) **310W 520D 150H**
Cut-Out (mm) **265W 490D**

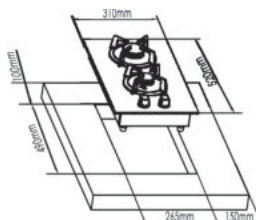

Price :
11,900 .-
Special Price :
8,990 .-

FS 7222 Onyx

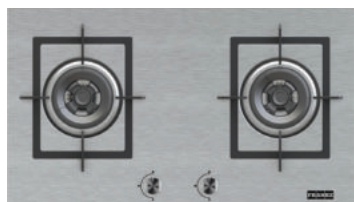

Master FUN Number
106.0588.913

Feature & Benefits
Left Burner 4.5kW
Right Burner 4.5kW
Flame Failure Device Equipped
Cast Iron Pan Support

Material **Stainless Steel**
Max Output **9 KW**
Exterior Dimension (mm) **740W 430D**
Cavity Dimension (mm) **650W 350D**

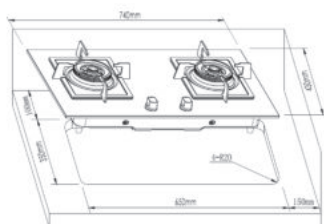

Price :
12,900 .-
Special Price :
8,590 .-

FHS 7212 Onyx



Master FUN Number
106.0530.869

Feature & Benefits
Left Burner 4.5kW
Right Burner 4.5kW
Flame Failure Device Equipped
Cast Iron Pan Support

Material **Stainless Steel**
Max Output **9 KW**
Exterior Dimension (mm) **710W 400D 150H**
Cavity Dimension (mm) **630W 330D**

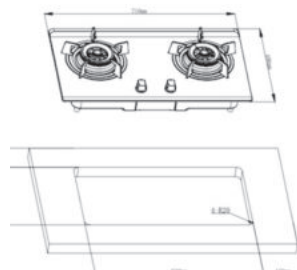

Price :
8,500 .-
Special Price :
6,590 .-



Hood



MYTHOS 2GETHER

A wonderful cooking liaison



Mythos 2gether:

a classy product combining cooking and suction power

The hob that comes with a hidden hood. Two ingredients that work together seamlessly.

If you desire elegance, minimalism and functionality, the Mythos 2gether is the ideal solution for your kitchen.

It combines an advanced induction hob with a very powerful hood. The new hob-hood is a sophisticated product for design and tech lovers.



Automatic switch

Whenever the hob is in use, the hood automatically switches on and delivers the exact suction power needed (up to 1200 m³ / h int).



Special cover in cast-iron

the hood is highly durable and heat-resistant: hot pans can be safely placed on it without damaging the material.



Hob-hood integration

The very powerful hood is seamlessly integrated into the hob. Pots and pans can be moved freely on the surface of the hob and hood without having to lift them.



Useful space

Thanks to its small motor, Mythos 2gether allows a lot of storage space in the cabinet underneath.

Hood



FME 407 GLASS BM Matt Black Mercury

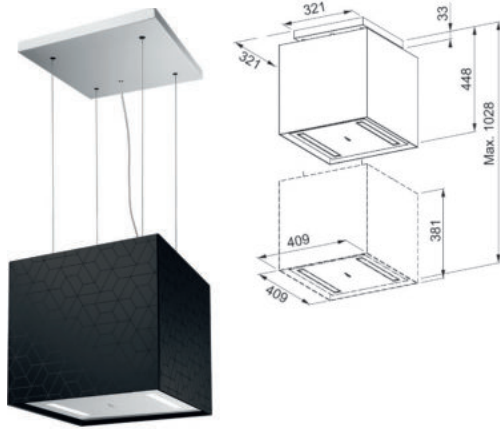

Master FUN Number
345.0601.430

Features & Benefits
Energy Efficiency Class A
Fan Efficiency Class A
24 Hour Continuous Ventilation
Filtering Function
3 Speed + Intensive

Material **Stainless Steel**
Type **Island**
MAX Air Flow **1000m³/h**
Lighting Type **2 x 4W LED**
MAX Noise Level **64dB(A)**
Exterior Dimensions (mm) **409W 409D 830-1028H**
Exhaust Diameter (mm) **150**
Carbon Filter Included **112.0016.755**
Remote Control Included **112.0174.991**

Price :
125,000 .-

Special Price :
96,500 .-

Special Order

FDW 908 IB XS FRANKE Downdraft

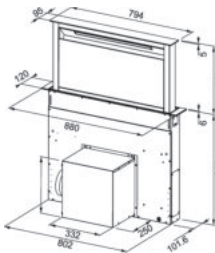

Master FUN Number
110.0365.588

Features & Benefits
Energy Efficiency Class B
Perimetric Extraction
Filter Saturation Indicator
Comfort Light
Digital Display
Comfort Light
Remote Control
4 Speed + Intensive

Material **Stainless Steel & Tempered Glass**
Type **Downdraft**
MAX Air Flow **800m³/h**
Lighting Type **1 x 7W LED**
MAX Noise Level **57dB(A)**
Exterior Dimensions (mm) **880W 370D 1052H**
Exhaust Diameter (mm) **150**
Carbon Filter **112.0262.703**
Remote Control **112.0174.991**

Price :
108,900 .-

Special Price :
81,900 .-

FCR 925 I TC BK XS LED Crystal

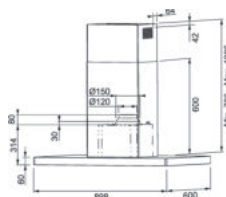

Master FUN Number
325.0518.709

Features & Benefits
Charcoal Filter B
Comfort Light
3 Speed + Intensive

Material **Stainless Steel & Tempered Glass**
Type **Island**
MAX Air Flow **1200m³/h**
Lighting Type **4 x 1W LED**
MAX Noise Level **67dB(A)**
Exterior Dimensions (mm) **898W 600D 730-1000H**
Exhaust Diameter (mm) **125**
Carbon Filter **112.0016.756**

Price :
53,900 .-

Special Price :
43,900 .-

Hood

FCR 925 TC BK/XS Crystal

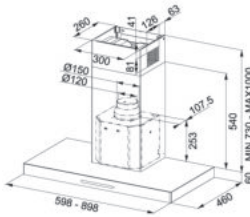

Master FUN Number
325.0654.002

Features & Benefits
Energy Efficiency class A+
LED Indicator
Comfort Light
3 Speed + Intensive
Energy Motor

Material **Stainless Steel**
Type **Wall-mounted**
MAX Air Flow **1200m³/h**
Lighting Type **2 x 1W LED**
MAX Noise Level **66dB(A)**
Exterior Dimensions (mm) **898W 460D 730-1000H**
Exhaust Diameter (mm) **150**
Carbon Filter **112.0016.756**

Price :
42,500 .-
Special Price :
32,000 .-

FCR 625 TC BK/XS Crystal

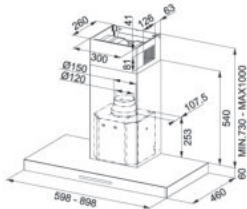

Master FUN Number
325.0653.923

Features & Benefits
Energy Efficiency class A+
LED Indicator
Comfort Light
3 Speed + Intensive
Energy Motor

Material **Stainless Steel**
Type **Wall-mounted**
MAX Air Flow **1200m³/h**
Lighting Type **2 x 1W LED**
MAX Noise Level **66dB(A)**
Exterior Dimensions (mm) **598W 460D 730-1000H**
Exhaust Diameter (mm) **150**
Carbon Filter **112.0016.756**

Price :
38,900 .-
Special Price :
29,900 .-

FSMD 508 Smart Deco

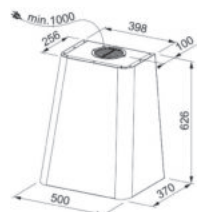

Master FUN Number
FSMD 508 GY

Light Grey *
335.0530.199

FSMD 508 RS

Matt Rose *
335.0530.201

FSMD 508 YL

Mustard Yellow
335.0530.202

FSMD 508 BL

Smokey Blue
335.0530.203

FSMD 508 GN

Dusty Green
335.0530.200

Feature & Benefits for Hood

Energy Efficiency class A
Lamp Efficiency Class A
3 Speed + Intensive

Material **Stainless Steel**
Type **Wall-mounted**
Max Air Flow **1200 m3/h**
Lighting Type **1 x 3W LED**
Max Noise Level **68db(A)**
Exterior Dimension (mm) **500W 370D 626H**
Exhaust Diameter (mm) **150**
Carbon Filter **112.0174.995**

Price :
49,500 .-
Special Price :
39,500 .-

FGL 925 I XS Glass Linear

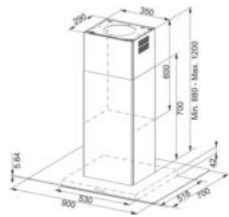

Master FUN Number
325.0590.061

Features & Benefits
Energy Efficiency Class B
Charcoal Filter C
3 Speed + Intensive

Material **Stainless Steel & Tempered Glass**
Type **Island**
MAX Air Flow **1200m³/h**
Lighting Type **4 x 1W LED**
MAX Noise Level **69dB(A)**
Exterior Dimensions (mm) **900W 700D 880-1200H**
Exhaust Diameter (mm) **125**
Carbon Filter **112.0016.756**

Price :
43,900 .-

Special Price :
33,900 .-

FDF EV8 120 XS Format

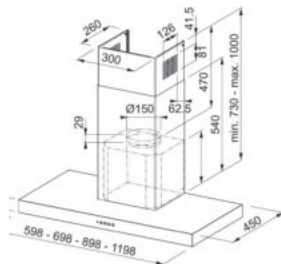

Master FUN Number
325.0599.548

Features & Benefits
Energy Efficiency class B
3 Speed + Intensive

Material **Stainless Steel**
Type **Wall-mounted**
Max Air Flow **1000 m³/h**
Lighting Type **4 x 1W LED**
Max Noise Level **69db(A)**
Exterior Dimension (mm) **1198W 450D 730-1000H**
Exhaust Diameter (mm) **150**
Carbon Filter **112.0016.756**

Price :
34,900 .-

Special Price :
25,900 .-

FGL 9115 XS* Glass Linear

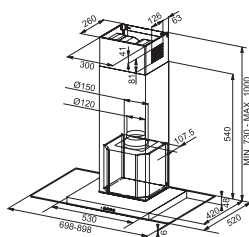

Master FUN Number
325.0541.079

Features & Benefits
Charcoal Filter C
Easy Fit System
3 Speed

Material **Stainless Steel & Tempered Glass**
Type **Wall-mounted**
MAX Air Flow **1000m³/h**
Lighting Type **2 x 4W LED**
MAX Noise Level **68dB(A)**
Exterior Dimensions (mm) **898W 520D 730-1000H**
Exhaust Diameter (mm) **125**
Carbon Filter **112.0016.756**

Price :
19,000 .-

Special Price :
14,900 .-

Hood

FDL 665 XS*

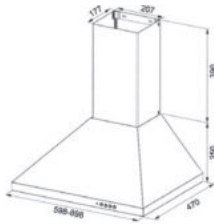

Master FUN Number
320.0521.537

Features & Benefits
3 Speed

Material **Stainless Steel**
Type **Wall-mounted**
Max Air Flow **1000 m3/h**
Lighting Type **2 x 4W LED**
Max Noise Level **68db(A)**
Exterior Dimension (mm) **598W 470D 640-720H**
Exhaust Diameter (mm) **150**
Carbon Filter **112.0016.755**

Include Chimney
991.0473.640

Price :
13,500 .-

Special Price :
10,900 .-

FSMT 905 XS Gemma T-Shape

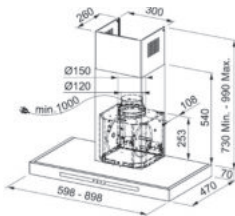

Master FUN Number
325.0653.979

Features & Benefits
Energy Efficiency Class B
3 Speed + Intensive

Material **Stainless Steel**
Type **Wall-mounted**
Max Air Flow **1000 m3/h**
Lighting Type **2 x 1W LED**
Max Noise Level **67db(A)**
Exterior Dimension (mm) **898W 470D 730-990H**
Exhaust Diameter (mm) **150**
Carbon Filter **112.0016.756**

Price :
25,900 .-

Special Price :
19,900 .-

CXW 268 FC 928 KB Onyx

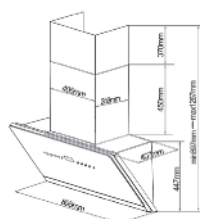

Master FUN Number
330.0539.174

Features & Benefits
Slide Touch Control
24 Hour Continuous Ventilation
3 Speed + Intensive

Material **Stainless Steel & Black Glass**
Type **Wall-mounted**
Max Air Flow **1600 m3/h**
Lighting Type **2 x 2W LED**
Max Noise Level **69db(A)**
Exterior Dimension (mm) **895W 407D 897-1267H**
Exhaust Diameter (mm) **185**

Price :
47,900 .-

Special Price :
37,900 .-

CXW 268 FT 926 CB Onyx

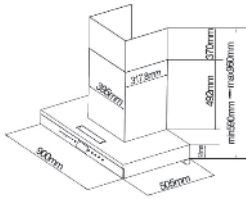

Master FUN Number
325.0539.172

Features & Benefits
Slide Touch Control
24 Hour Continuous Ventilation
3 Speed + Intensive

Material **Stainless Steel & Black Glass**
Type **Wall-mounted**
Max Air Flow **1600 m³/h**
Lighting Type **2 x 1.5W LED**
Max Noise Level **69db(A)**
Exterior Dimension (mm) **900W 505D 590-960H**
Exhaust Diameter (mm) **185**

Price :
37,300 .-

Special Price :
28,000 .-

CXW 220 FT 920 M Onyx

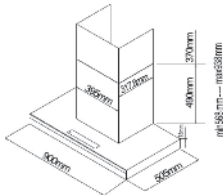

Master FUN Number
325.0539.167

Features & Benefits
Touch Control
3 Speed

Material **Stainless Steel & Black Glass**
Type **Wall-mounted**
Max Air Flow **1600 m³/h**
Lighting Type **2 x 1.5W LED**
Max Noise Level **69db(A)**
Exterior Dimension (mm) **900W 505D 590-960H**
Exhaust Diameter (mm) **185**

Price :
25,900 .-

Special Price :
19,900 .-

CXW 220 FT903P

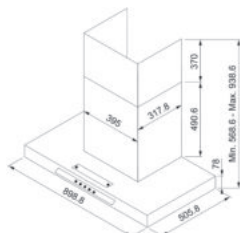

Master FUN Number
325.0539.170

Features & Benefits
Touch Control
3 Speed

Material **Stainless Steel**
Type **Wall-mounted**
MAX Air Flow **1600**
Lighting Type **2 x 3W LED**
MAX Noise Level **70db(A)**
Exterior Dimensions (mm) **900W 508D 638-938H**
Exhaust Diameter (mm) **185**

Price :
20,500 .-

Special Price :
15,900 .-

Hood

CXW 220 FT905 M TH Onyx



Master FUN Number
325.0655.261

Features & Benefits
Touch Control
3 Speed + Intensive

Material **Stainless Steel & Black Glass**
Type **Wall-mounted**
MAX Air Flow **1500**
Lighting Type **2 x 3W LED**
MAX Noise Level **70dB(A)**
Exterior Dimensions (mm) **895W 470D 557-935H**
Exhaust Diameter (mm) **195**

Price :
18,700 .-

Special Price :
14,500 .-

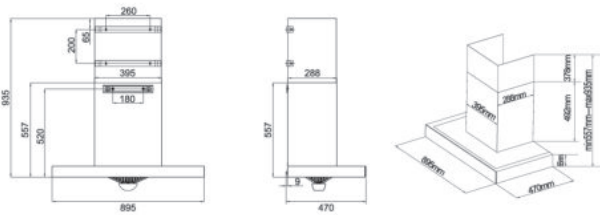

ARNO 90 XS/BK Arno



Master FUN Number
325.0608.800

Features & Benefits
Touch Control
9 Speed
Energy Efficiency Class A+

Material **Stainless Steel & Black Glass**
Type **Wall-mounted**
MAX Air Flow **1000**
Lighting Type **LED**
MAX Noise Level **67db(A)**
Exterior Dimensions (mm) **895W 500D 528-978H**
Exhaust Diameter (mm) **150**
Carbon filter **112.0569.559**

Price :
17,500 .-

Special Price :
12,500 .-

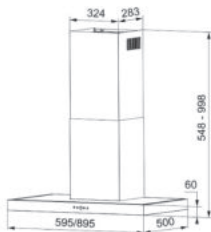

FD6005A 604 XS



Master FUN Number
110.0258.241

Features & Benefits
3 Speed

Material **Stainless Steel**
Type **Wall-mounted hood**
MAX Air Flow **500m³/h**
Lighting Type **2 x 40W Candle Lamp**
MAX Noise Level **52dB(A)**
Exterior Dimensions (mm) **600W 500D 150H**
Exhaust Diameter (mm) **125**
Carbon Filter **133.0265.645**

Price :
7,900 .-

Special Price :
6,200 .-

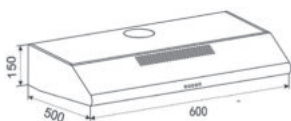

FTC 912 XS LED

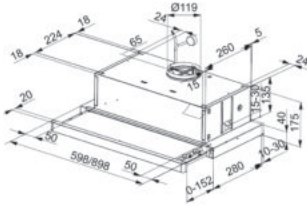

Master FUN Number
315.0532.377

Features & Benefits
3 Speed

Material **Stainless Steel & Painted**
Type **Slim line**
MAX Air Flow **600m³/h**
Lighting Type **2 x 4W LED**
MAX Noise Level **69dB(A)**
Exterior Dimensions (mm) **900W 280D 175H**
Exhaust Diameter (mm) **150**
Carbon Filter **112.0067.942**

Price :
10,500 .-

Special Price :
7,900 .-

FTC 601 BK/GL

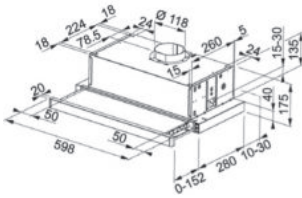

Master FUN Number
110.0439.279

Features & Benefits
3 Speed

Material **Stainless Steel & Painted**
Type **Slim line**
Max Air Flow **800 m³/h**
Lighting Type **2 x 1W LED**
Max Noise Level **67db(A)**
Exterior Dimension (mm) **598W 280D 175H**
Exhaust Diameter (mm) **125**
Carbon Filter **112.0067.942**

Price :
10,900 .-

Special Price :
8,490 .-

FTC 632L GR

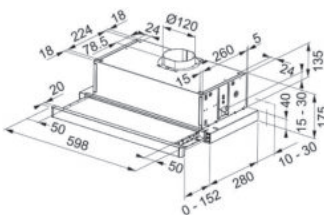

Master FUN Number
315.0547.796 / XS
315.0547.798 / BK

Features & Benefits
3 Speed

Material **Stainless Steel & Painted**
Type **Slim line**
MAX Air Flow **600m³/h**
Lighting Type **2 x 4W LED**
MAX Noise Level **67dB(A)**
Exterior Dimensions (mm) **598W 280D 175H**
Exhaust Diameter (mm) **125**
Carbon Filter **112.0564.564**

Price :
6,700 .-

Special Price :
5,300 .-

FBI 525 GR*

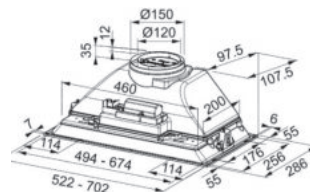

Master FUN Number
305.0599.532

Features & Benefits
3 Speed

Material **Stainless Steel**
Type **Standard**
MAX Air Flow **600m³/h**
Lighting Type **2 x 4W LED**
MAX Noise Level **67dB(A)**
Exterior Dimensions (mm) **522W 286D 204H**
Exhaust Diameter (mm) **150**
Carbon Filter **112.0564.564**

Price :
6,590 .-

Special Price :
4,990 .-





Oven

THE NEW MYTHOS OVEN

Only the best for your kitchen



When friends and family come over, we spend most of the time in the kitchen – talking, laughing, and cooking together. Franke has found a way to make food preparation easier and has developed new, elaborate ovens. Now every part of cooking will be even more enjoyable.



Microwave-combi oven, and Oven

Microwave ovens have been designed to be combined with Franke built-in multifunction ovens. Perfect aesthetics and maximum customization both for the combination in gallery configuration and for column alignment.



Wider muffle

Up to 73 liters for the Mythos ovens and 71 liters for Maris and Smart. The large cavity allows you to cook several at the same time dishes while maintaining the flavor of each one unchanged and ensuring optimal cooking.



Keep it gentle

The door on your new oven closes gently, softly, and silently. The Smooth2Close feature brings a sense of serenity and charm into the family kitchen and makes the whole atmosphere more friendly.



Clean as a whistle

Now you can enjoy your oven even more. With the pyrolytic cleaning function, it will clean itself and transform all leftovers into ashes that can easily be wiped away.

Oven

FMY 99 P XS Mythos

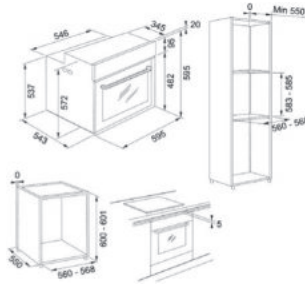

Master FUN Number
116.0613.708

Features & Benefits
Energy Efficiency Class A+
Full touch color TFT Display
Exclusive Programs: Cookassist with 42 automatic recipes + 15 special functions
Complete Menu Program up to 4 levels
Fullglass counter door
Pyrolytic Cleaning

Material **Tempered Glass**
Capacity **73L**
No. of Function **17**
Exterior Dimensions (mm) **595W 543D 595H**
Cavity Dimensions (mm) **560W 550D 600H**
Standard Equipment **2 Grid, 1 Baking Tray, 1 Deep tray**



Price :
114,500 .-
Special Price :
91,900 .-

FMA 97 P XS Maris

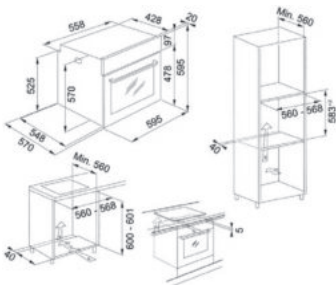

Master FUN Number
116.0606.100

Features & Benefits
Energy Efficiency Class A+
White LED Display and Knobs push pull
Exclusive Programs: Bread and Pastry
Multicooking function up to 3 levels
Pyrolytic Cleaning

Material **Tempered Glass**
Capacity **71L**
No. of Function **9**
Exterior Dimensions (mm) **595W 548D 595H**
Cavity Dimensions (mm) **560W 560D 600H**
Standard Equipment **2 Grid, 1 Baking Tray, 1 Deep tray**



Price :
78,900 .-
Special Price :
63,900 .-

FSM 97 P XS Smart

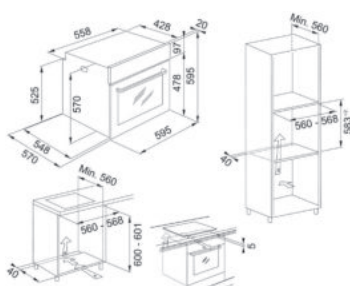

Master FUN Number
116.0606.096

Features & Benefits
Energy Efficiency Class A+
White LED display and knobs
Exclusive Programs: Bread and Pastry
Multicooking function up to 3 levels
Pyrolytic Cleaning

Material **Tempered Glass**
Capacity **71L**
No. of Function **9**
Exterior Dimensions (mm) **595W 548D 595H**
Cavity Dimensions (mm) **560W 560D 600H**
Standard Equipment **2 Grid, 1 Baking Tray, 1 Deep tray**



Price :
52,900 .-
Special Price :
42,900 .-

FMXO 86 S XS

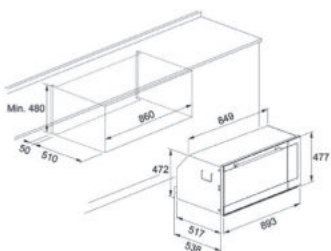

Master FUN Number
116.0613.109

Features & Benefits
Energy Efficiency Class Oven A
Cold Door
Natural Static Cooking
Fan Assisted Cooking
Fan Assisted Conventional Cooking

Material **Stainless Steel & Tempered Glass**
Capacity **84L**
No. of Function **8**
Exterior Dimensions (mm) **893W 538D 477H**
Cavity Dimensions (mm) **860W 510D 480H**
Standard Equipment **2 Grid, 1 Deep tray**



Price :
78,900 .-

Special Price :
63,900 .-

FO40004 810 M G

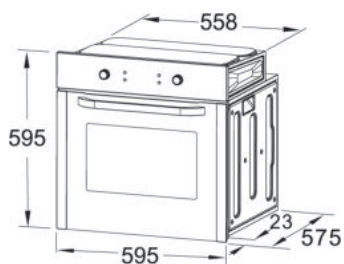

Master FUN Number
116.0324.723

Features & Benefits
8 Cooking Functions
Touch Control
Big LCD Display

Material **Stainless Steel & Tempered Glass**
Capacity **70L**
No. of Function **8**
Exterior Dimensions (mm) **595W 575D 595H**
Cavity Dimensions (mm) **560W 565D 580H**
Standard Equipment **1 Deep Tray, 1 Grid**



Price :
35,000 .-

Special Price :
26,000 .-

FO40012 96 M XS

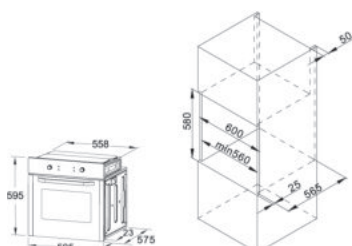

Master FUN Number
116.0287.917

Features & Benefits
9 Cooking Functions
LCD Display

Material **Stainless Steel & Tempered Glass**
Capacity **65L**
No. of Function **9**
Exterior Dimensions (mm) **595W 575D 595H**
Cavity Dimensions (mm) **560W 565D 580H**
Standard Equipment **1 Deep Tray, 2 Grid**



Price :
28,900 .-

Special Price :
21,900 .-

Microwave Oven

FMY 45 MW XS Mythos

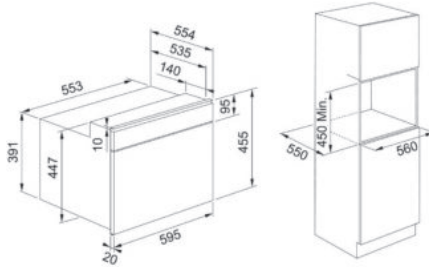

Master FUN Number
131.0606.105

Features & Benefits
Microwave 0.9 kW
Grill Cooking 1.6 kW
Turbo Grill
Forced Air
Quick Heat
Auto Defrost/Reheat/Steam
Cooking Guide

Material **Tempered Glass**
Type **Built-in**
Microwave output power **0.9kW**
Capacity **40L**
No. of Function **12**
Exterior Dimensions (mm) **595W 554D 455H**
Cavity Dimensions (mm) **560W 550D 450H**

Price :
104,900 .-
Special Price :
82,000 .-

FMA 45 MW XS Maris

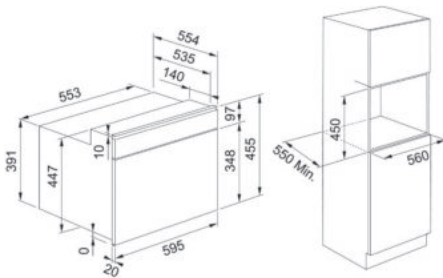

Master FUN Number
131.0606.104

Features & Benefits
Microwave 0.9 kW
Grill Cooking 1.6 kW
Turbo Grill
Forced Air
Auto Defrost/Reheat
Cooking Guide

Material **Tempered Glass**
Type **Built-in**
Microwave output power **0.9kW**
Capacity **40L**
No. of Function **10**
Exterior Dimensions (mm) **595W 554D 455H**
Cavity Dimensions (mm) **560W 550D 450H**

Price :
89,000 .-
Special Price :
75,000 .-

FMO6200BX SEA* ONYX

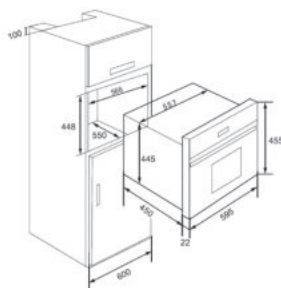

Master FUN Number
131.0580.564

Features & Benefits
Microwave 1.0 kW
Grill Cooking 1.5 kW
Fast Cooking
Auto Defrost/Reheat
Cooking Guide

Material **Tempered Glass**
Type **Built-in**
Microwave output power **1.0kW**
Capacity **35L**
No. of Function **4**
Exterior Dimensions (mm) **595W 555D 455H**
Cavity Dimensions (mm) **560W 550D 448H**

Price :
46,900 .-
Special Price :
39,900 .-

FMWO 25 NH G I IND

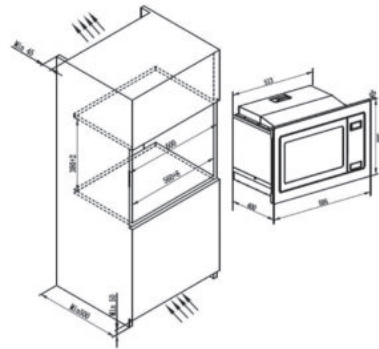

Master Fun Number
131.0289.434

Feature & Benefits
Microwave 0.9kW
Microwave Grill 1.0kW
8 Auto Menus
Grill Function
Defrost
Child Lock
LCD Display

Material **Tempered Glass**
Type **Built-in**
Microwave output power **1.45kW**
Capacity **25L**
No. of Function **8**
Exterior Dimension (mm) **595W 400D 388H**
Cavity Dimension (mm) **568W 550D 382H**

Price :
38,900 .-

Special Price :
29,900 .-

FSM 25 MW XS

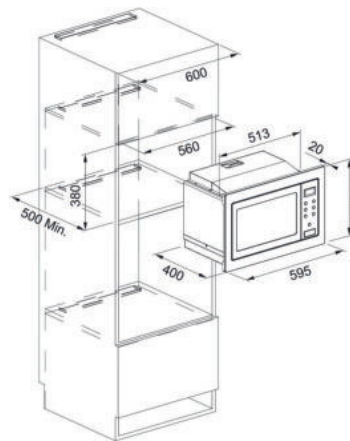

Master Fun Number
131.0627.471

Feature & Benefits
Microwave 0.9 kW
Grill Cooking 1.0 kW
Fast Cooking
Auto Defrost/Reheat
Cooking Guide

Material **Tempered Glass**
Type **Built-in**
Microwave output power **0.9kW**
Capacity **25L**
No. of Function **7**
Exterior Dimensions (mm) **595W 400D 388H**
Cavity Dimensions (mm) **560W 500D 380H**

Price :
41,500 .-

Special Price :
31,500 .-

FMWO 25 NHI

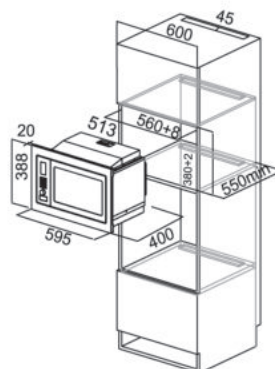

Master Fun Number
131.0289.420

Feature & Benefits
Microwave 0.9kW
Microwave Grill 1.0kW
8 Auto Menus
Grill Function
Defrost
Child Lock
LCD Display

Material **Stainless Steel**
Type **Built-in**
Microwave output power **0.9kW**
Capacity **25L**
No. of Function **8**
Exterior Dimension (mm) **595W 400D 388H**
Cavity Dimension (mm) **568W 500D 382H**

Price :
29,900 .-

Special Price :
22,900 .-



A detailed view of the interior of a dishwasher. The top rack is filled with various pieces of silverware, including knives, forks, and spoons, neatly arranged. Below it, the middle rack holds several white ceramic plates and a blue glass. The bottom rack is filled with white ceramic plates, some standing upright. The dishwasher's interior is made of stainless steel, and the racks are also made of stainless steel. The overall appearance is clean and organized.

Dishwasher

THE NEW DISHWASHER

Host more guests





Don't worry about the dishes. With one of the most efficient, Franke Built-In Dishwashers which maximize use of internal space with a cutlery basket and sliding tray. All dishwashers come with a half-load option reducing the use of water and energy when they are not full. Most models even have dirt detectors measuring the amount of dirt that has to be removed and thus adjusting the use of power and water quantity and temperature. You can even wash up your dishes while sleeping. The Franke Built-In Dishwashers are super-silent. Choose yours.



3rd basket cutlery tray

The dishwasher has a greater optimization distribution of water, a better cleaning of the cutlery and offers a large internal space. This ensures maximum flexibility in the positioning of all cutlery and long utensils.



Smart washing

Automatic Program is ideal for normally soiled dishes with dried food residues. The automatic function senses the level of soiling on the dishes and adjusts the program accordingly.



Flexible program

Versatile offer to meet different needs. Franke dishwasher has up to 14 place settings and numerous washing program, becoming the ideal solution for every need.



Long panel

This feature is in line with the trends and evolutions of contemporary style. The long panel dishwasher is designed to fit into kitchens with a lowered plinth. With the innovative sliding hinges, product installation is very simple and allows maximum flexibility in adjustment height.



FRANKE

- 1 ECO 50°
- 2 AUTO
- 3 65°
- 4 30° 50°
- 5 30°
- 6 45°
- 7

9L

FDW 614 D10P DOS

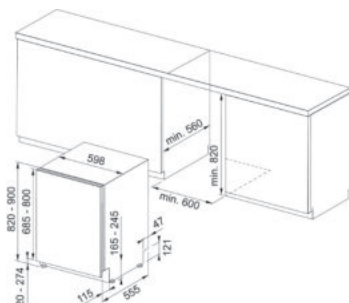

Master FUN Number
117.0611.675

Features & Benefits

New EU Energy efficiency
Washing class A
Drying class A
10 Programs
Low noise level (41 dB)
LED Display
Super Silent
Light-On-Floor
DOS (Door Open System)
Sliding Hinge

Type **Fully integrated**

Capacity **14 SETs**

No. of Function **10**

Exterior Dimensions (mm) **598W 555D 820-900H**

Cavity Dimensions (mm) **600W 560D 820H**

Panel **112.0037.279 (Not include)**

Free 1 Pack!

with purchase of a Dishwasher



Price :

78,900 .-

Special Price :

63,900 .-

FDW 613 E5P F

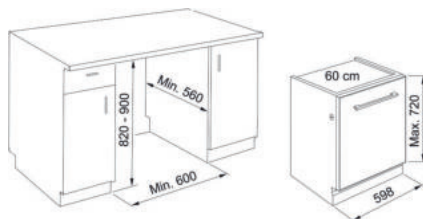

Master FUN Number

117.0611.672

Features & Benefits

New EU Energy efficiency
Washing class A
Drying class A
5 Programs
Low noise level (49 db)
LED Display

Type **Fully integrated**

Capacity **13 SETs**

No. of Function **5**

Exterior Dimensions (mm) **598W 555D 820-900H**

Cavity Dimensions (mm) **600W 560D 820-900H**

Panel **112.0037.279 (Not include)**

Free 1 Pack!

with purchase of a Dishwasher



Price :

58,900 .-

Special Price :

47,900 .-

FDWF 814 D A++ XS

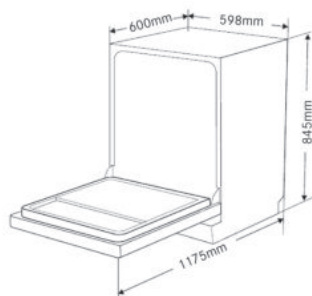

Master Fun Number

117.0547.341

Feature & Benefits

Energy class A++
Washing class A
Drying class A
8 Programs
Light load
Strengthen drying
Removable top

Type **Freestanding**

Capacity **14 SETs**

No. of Function **8**

Rated Power **1.76kW**

Exterior Dimensions (mm) **598W 600D 850H**

Free 1 Pack!

with purchase of a Dishwasher



Price :

40,000 .-

Special Price :

29,000 .-





Waste Disposer

WASTE DISPOSER

Keep the kitchen hygienic



Designed to liquefy organic waste so it can be harmlessly flushed into the sewer, returning biodegradable materials back to the earth, Waste Disposers are discreet, easy to install and energy and water efficient. Equipped with an antimicrobial agent, Bio Shield®, that will reduce odor causing bacteria, and the Silver Guard®* feature that offers a magnetic rim to prevent metal objects from falling into the disposer.

*On selected models



Silver Guard®

In a perfect world, only food waste falls into the disposer, but we know this is not every day life. Sometimes things fall in that shouldn't. So we've added Silver Guard - a magnetic rim that keeps metal objects from falling into the disposer.*



Powerful, Efficient Motor

Full torque at initial revolution uses less water and electricity and gets the job done quickly.



Hygienic Kitchen

Our disposers have Bio Shield® antimicrobial agents molded into the internal components which inhibits the growth of bacteria and reduces odors, so you can rest easy knowing your kitchen will smell as good as it looks.



Easy to Install

Three bolt mounting system for a fast easy installation.

TE-75

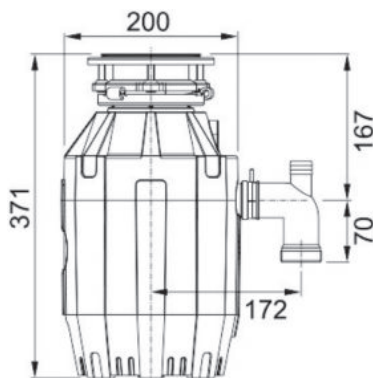

Master FUN Number
134.0552.537

Features & Benefits
3/4HP
1400ML
2700rpm/min
65dB/A
Overload Protection
Stainless Steel Impeller Blade
Air Switch
EMC Filter

Material **Stainless Steel & Painted**
Type **Built-in**
Electrical Voltage **50 - 60Hz**
Electrical Frequency **220 - 240V**
Rated Power **550W**
Exterior Dimensions (mm) **200W - D - H**

Price :
15,900 .-
Special Price :
10,390 .-



FRANKE KITCHEN CARE

STAINLESS STEEL SINK CLEANER

Professional cleaning and care results for your Franke stainless steel sink

REINIGER FÜR EDELSTAALSPÜLEN
NETTOYANT POUR ÉVIERS EN INOX
Detergente per lavelli in acciaio inossidabile



FRANKE

MAKE IT WONDERFUL

e 200 ml / 7.04 fl.oz

A close-up photograph of a kitchen countertop. The countertop is made of a dark wood with a vertical grain pattern. In the foreground, a stainless steel sink is partially visible. To the right of the sink, there are several lemons with green leaves. In the background, a black mortar and pestle sits on a dark tray, and a small black bowl containing white salt is also on a tray. The word "Accessory" is written in a bold, black, sans-serif font on a white rectangular background that is semi-transparent and positioned over the middle of the image.

Accessory

Accessory

ANDY CHEF

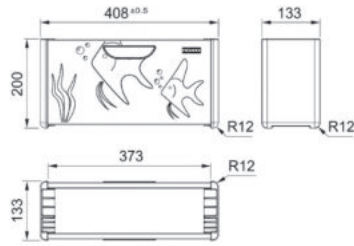

Master FUN Number
112.0619.946

Features & Benefits
Andy Chef accessories kit works smartly and efficiently with your Franke Box® bowl sink in creating a perfectly organized workstation. The innovative designer kit features a case, a stainless steel strainer bowl, a walnut chopping board, and a chef's knife. With a little help from Andy Chef, you'll keep your kitchen tidy, organized, and ready for creating culinary wonders, day and night.

Dimension (mm) 133W 408D 200H

Price :
13,500 .-
Special Price :
10,900 .-

Waste Bin *



Master FUN Number
134.0032.204

Features & Benefits
Built-in waste bin
capacity 12 litres
Size : Ø 335 mm.

Price :
5,100 .-
Special Price :
3,900 .-

Rolling mat

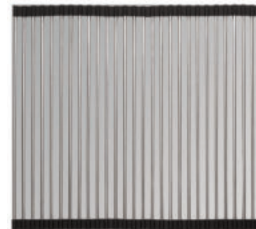

Master FUN Number
112.0050.988

Features & Benefits
Roll mat / Stainless Steel
Size : 400 x 400 mm.

Price :
2,500 .-
Special Price :
1,990 .-

Panel Inox DW 60 ST



Master FUN Number
112.0037.279

Features & Benefits
Dishwasher panel with handle
suitable for FDW 614 D10P DOS
FDW 613 E5P F
Size : 596 x 720 mm.

Price :
16,900 .-
Special Price :
12,900 .-

Pasta Inox



Master FUN Number
112.0158.200

Features & Benefits
Anti-Age stainless steel
Cleaner cream 300 g.

Price :
650 .-
Special Price :
490 .-

Stainless Steel Sink Cleaner



Master FUN Number
112.0530.237

Features & Benefits
Stainless steel sink cleaner 200 ml. For cleaning and care of stainless steel sink surfaces. Ideal for intensive cleaning and daily cleaning

Price :
590 .-
Special Price :
450 .-

Colored Sink Cleaner



Master FUN Number
112.0530.238

Features & Benefits
Colored sink cleaner 250 ml. For cleaning and care of Fraganite and Tectonite sink

Price :
590 .-
Special Price :
450 .-

Tap Cleaner



Master FUN Number
112.0530.239

Features & Benefits
Tap cleaner 250 ml. For cleaning and care of tap surfaces. Ideal for intensive cleaning and daily cleaning

Price :
590 .-
Special Price :
450 .-

Hob Cleaner



Master FUN Number
112.0530.322

Features & Benefits
Hob cleaner 250 ml. For cleaning and care of Franke ceramic, gas and induction hobs. Ideal for intensive cleaning and daily cleaning

Price :
590 .-
Special Price :
450 .-

Soap dispenser

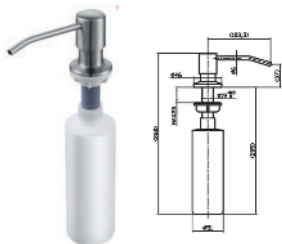

Master FUN Number
119.0181.657

Price :
790 .-

Features & Benefits
Soap dispenser

Special Price :
590 .-

Carbon filter for Hood FTF



Master FUN Number
112.0017.979

Price :
1,200 .-

Carbon filter for Hood FTF
(1 pc. / 1 set)

Special Price :
850 .- /1 Set

Carbon filter for Hood



Master FUN Number
133.0331.970

Price :
1,800 .-

Carbon filter for Hood FFG/FFN

133.0658.015
Carbon filter for Hood FFG XS (700)
(2 pcs. / 1 set)

Special Price :
1,390 .- /1 Set

Carbon filter for Hood FMY



Master FUN Number
112.0016.755

Price :
1,700 .-

Carbon filter for Hood FMY
(2 pcs. / 1 set)

Special Price :
1,290 .- /1 Set

Carbon filter for Hood

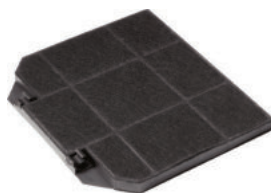

Master FUN Number
112.0016.756

Price :
1,800 .-

Carbon filter for Hood
FCR, FGL, FDF, FTU, FGC, FDL
(1 pc. / 1 set)

Special Price :
1,390 .- /1 Set

Carbon filter for Hood

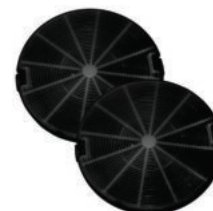

Master FUN Number
43500038

Price :
2,000 .-

112.0067.942
FBI 512/FTC 6032, 601, 612, 912

Special Price :
1,290 .- /1 Set

Carbon filter for Hood



Master FUN Number
112.0564.564

Price :
2,000 .-

Carbon filter Hood FBI 532, FTC 632
(2 pcs. / 1 Set)

Special Price :
1,290 .- /1 Set

Baking Programs

Natural Static Cooking	Fan Assisted Conventional Cooking	Forced Air Eco	Forced Air	Grill	Turbo Grill
Maxi Cooking	Pizza	Cookassist	Bread Auto	Bread	Dessert Auto
Dough Resting	Defrost	Preheat	Pyrolytic Cleaning	Multicooking	
Energy Class Ovens A	Fan assisted Conventional Cooking	Grill Cooking	Dough Resting	Natural Static Bottom Cooking	Large grill
Large grill with Fan	Defrosting	Cold Door	Comfort Light	Convection	3D Broiling
Top Roasting	Fan Circulation	Standard BBQ Grilling	Top and Bottom Heating	Hot Wind Roasting	Strong Wind BBQ Grilling
Defrost	Fan Assisted Grill Cooking	BBQ Hot Grill	Fan Assisted Cooking		



FRANKE

Franke (Thailand) Co.,Ltd.
689 Bhiraj Tower at Emquartier,
20th Floor, Unit 2007,
Sukhumvit Road, Klongton Nuea,
Wattana, Bangkok 10110
Thailand
Telephone +66(0)2 013 7900
Fax +66(0)2 013 7999
E-mail : ks-info.th@franke.com
Line Official : @FrankeThailand

Franke Service Center
Telephone +66(0)2 013 7960-3
Mobile +66-92-841-0407
www.franke.com/th



All pictures, specifications and other content in this catalogue are the property of Franke and shall not be reproduced in any form of media without the expressed written permission from Franke.

All product images and specifications are subject to the actual technical data. Franke reserves the right to make any changes and modifications, without prior notice, resulted from technology development.

Printed in May, 2022